



Analog Modeling MIDI Synthesizer

for bass, guitar, keyboard and other instruments

User Guide Version 4.11

October 15, 2024

Written by Peter Kenney and Andras Szalay

Panda-Audio Ltd.

www.panda-audio.com

Product website: www.pandamidi.com

Table of Contents

What's in the Box?	5
Introduction	6
The Evolution of the Future Impact	7
New Features of the V4 Platform	7
Main Features	8
Top Panel Controls and Display	9
Connections	9
Quick-Start Guide	10
Setting up the Future Impact V4	10
Operating the Future Impact V4	11
Playing the Future Impact V4	11
Tuner	11
Editing the Sounds and the Playing Response	12
Writing Parameter Edits into the Program File	13
Parameter Descriptions	14
Choosing the Startup Sound	15
Setting the Instrument Mode and Resetting the Parameters	15
A Quick Word About Firmware	16
Detailed Manual	17
The Global Menu	18
The Instrument Modes	21
Control Voltage (CV) Triggering	22
CV Calibration	23
MIDI Triggering	24
Updating the Firmware of the Future Impact V4	27
The Future Impact V4 Editor Suite	28
Installing the Future Impact V4 Editor Suite	29
Connecting to the Future Impact V4 Editor Suite	29
Using midiBeam 4Control with the Editor Suite	30
The Menu Bar	30
The File Menu	30
The Edit Menu	33
The View Menu	34
The Help Menu	34
The Manager	35
File Commands	36
Bank Commands	38
Program Commands	39

The Editor	41
The Program Display	42
On-Screen Keyboard and Mod Wheel	42
Block Reset & Randomize Tool	43
VCO & Flexi Copy Tool	44
Alternative Editor Skin	44
Editor Parameters	45
Pitch Tracking	45
VCO Block	46
Foldover Distortion	50
Distortion Block	50
Envelopes Block	51
Envelope Mode Behavior	53
VCF Block	54
VCF INPUT	54
Attack/Release Distortion	55
FILTER	55
LFO Block	58
MIDI Block	59
Internal MIDI Tab	59
External MIDI Tab	61
Main Mixer Block	62
Effects Block	63
Effect 1: Overdrive	64
Effect 2: Equalizer	65
Effect 3: Chorus	66
Effect 4: Delay	68
Tap Tempo	69
Adjusting Effects with the PARAMETER and EDIT Dials	70
Flexi Controllers	70
A Flexi Controller in Action	74
More on Flexi Range Control	75
Special Flexi-Only Modulation Sources	76
Pulse Width Settings	77
MIDI Clock Sync of LFO4	78
Some Ideas for Uses of Flexi Controllers	78
MIDI Controllers as Flexi Controller Sources and Range Controls	80
MIDI	81
Setting the MIDI Channel	81
MIDI Thru	81
Program Change Out	82
MIDI-Related Performance Features	83

[Go to Table of Contents](#)

Expression	83
Sustain	83
MIDI Implementation	84
Building Your First Sound	88
Synth Sounds	88
Distortion Sounds	89
Tutorials	90
FI4 as a Replacement for Standard Single-Effect Pedals	90
FI4 as Envelope Filter	90
FI4 as Chorus	91
FI4 as Flanger	92
FI4 as Phaser	92
FI4 as Tremolo	92
FI4 as Vibrato	93
FI4 as Reverb	93
FI4 as Delay	93
FI4 as Octaver	93
FI4 as Pedal Wah	94
Specifications	95
Appendix	98
Algorithm Block Diagrams	99
VCF Frequency Lookup Table	102
LFO Frequency Lookup Tables	104
VCO1-4 Pulse Width LFO and VCO LFO3	104
VCO4 LFO	106
Flexi Split Curves Lookup Table	108
Warranty Information	110
Frequently-Asked Questions (FAQs)	111

What's in the Box?



Box contents:

- A Future Impact V4 pedal;
- A Quick-Start Guide.

Items required but not included:

- A 9V stabilized, 200mA, center-negative, Roland-Boss-type power supply;
- A MIDI interface and two MIDI cables for use with either a PC (Windows 7 and above) or MAC (OS X 10.6 (Snow Leopard) and above).
(Minimum screen resolution - 640x480 (VGA, at 50% zoom of the Editor window).)

[Go to Table of Contents](#)

Introduction

Thank you for purchasing the latest incarnation of our revered synthesizer effects pedal: **Future Impact V4**.

The Future Impact V4 harnesses all the power and versatility of some of the best (and best-loved) keyboard synthesizers and squeezes it into a small and portable stomp-box pedal format, making those wonderfully-inspiring and sometimes other-worldly sounds available to all instrumentalists.

You now have in your hands the means to create and play classic synthesizer sounds like those heard on recordings by Herbie Hancock, George Duke, Stevie Wonder, Vince Clarke, Joe Zawinul, Chick Corea, Jan Hammer, Keith Emerson and countless others.

The Future Impact V4 (FI4) is an incredibly versatile pedal and the range of sounds it is capable of producing is quite staggering. In addition to producing synthesizer sounds such as basses, leads and pads, it can function as an octaver, chorus, flanger, phaser, distortion, envelope filter, traditional wah-wah, tremolo, reverb, delay, etc. and even has a built-in tuner. As such, it can potentially replace a whole pedalboard of dedicated single-effect pedals. It has a relay-switched true bypass so your input signal is unaffected when the pedal is off.

The FI4's synthesizer is monophonic, that is, it can only respond to input of one note at a time and (usually) outputs a single note. It *can* be set up to play chords but won't respond to chordal input. (Polyphonic input is however possible when not triggering the oscillators.) The original FI was designed for use with bass guitar, but in v3 the pitch range was extended, allowing it to be used with higher-pitched instruments too. In several places in this manual the input instrument is referred to as "bass/guitar" as these are still the most typically-used instruments, however, please remember that *any* pitched instrument that can be played monophonically can be used. Additionally the FI4 can be used as a monophonic synthesizer expander by connecting a keyboard, wind controller, computer or any other MIDI source to the MIDI input port. It can also be used to trigger synthesizers via 1V/Octave CV and MIDI.

There are 99 onboard sounds but via the companion [Editor Suite](#), you have access to many more, either by downloading and transferring them to the pedal or by creating them yourself.

In its previous iterations, the FI was already a powerfully expressive instrument. With the brand new hardware and software improvements introduced now in V4, it retains its place at the very forefront of synthesizer effects pedals.

In the next pages you will be shown the FI4's features, controls, display and connections. Following that is a [Quick-Start Guide](#). It explains how to use the FI4 with a bass guitar and will allow you to dive right in to playing the pedal with the minimum of fuss. Below that is the [Detailed Manual](#), which contains a complete description of how to use all the features of the pedal and the accompanying software Editor Suite.

[Go to Table of Contents](#)

The Evolution of the Future Impact

The Future Impact is the subject of one of those heartwarming stories of the internet as a force for good. It began life back in late 2014 when an enthusiastic member of the Talkbass forum tracked down Andras Szalay to ask him if he could reissue the discontinued Deep Impact he had designed for Akai. However, Andras had much more ambitious plans: the FI was conceived of not as a reissue, but as an entirely new and vastly-improved pedal. The project garnered tremendous support from forum members who funded the first batch of 100 pedals in late 2015. From there, the FI's popularity and reputation grew; ever more people clamored to own one, including notable players such as Chris Wolstenholme (Muse), Doug Wimbish (Living Colour, The Rolling Stones) and Bootsy Collins. Thanks to generous input from members of the online bass-playing community, the FI went from strength to strength.

With each successive update, we gradually added more and more features and refinements. With the v3.60 update of June 2021, we had to admit that we had finally squeezed every last drop of juice out of the pedal: we had completely exhausted the available code space.

In order to continue developing our ideas further, we have thus had to move to new hardware and implement a new firmware structure. While the FI4 can load patches from all the previous versions of the FI, unfortunately v3 users cannot run the V4 firmware or V4 patches on their device. However, the good news is that our new platform gives us the breathing space to develop well into the future. We already have big plans, so stay tuned!

New Features of the V4 Platform

- **CV/Gate & MIDI note output** - Simultaneously trigger other synths via the pedal;
- **Detented Parameter dial with extended range** - More variations on each sound;
- **Sturdier knobs** - The potentiometer shafts are now made from solid metal;
- **Long Release** - Audio-triggered sounds now use the full release time of the ADSR;
- **Oscillator sync** - VCO2 can sync to VCO1 for more harmonically-complex sounds;
- **Improved audio fidelity** - New ultra-low-noise CoDec and noise-reduction coding;
- **Overwrite programs** - On-pedal edits can be saved to patch data before uploading;
- **Superior pitch tracking** - Greatly reduced latency and increased sensitivity to input instrument dynamics. Pitch detection can now be set to prioritize speed or accuracy;
- **Octave transposition** - Two new MIDI CCs to transpose the pitch by ± 2 octaves;
- **63 new Flexi curves** - Create a split point between any two adjacent semitones;
- **Robust firmware update process** - Now *any* MIDI interface can be used;
- **Alternative quick access to Global Menu** - Enter/exit menu without power cycling;
- **Better Global Menu layout** - Items are repositioned and more meaningfully labelled;
- **Fresh Editor look** - An updated color scheme with a clearer and more logical layout;
- **Onscreen Mod Wheel** - Send out MIDI CCs or Aftertouch directly from the Editor;
- **Full midiBeam 4Control integration** - MIDI signals from expression pedals and switches are automatically passed to the FI4 when connected to the Editor.

[Go to Table of Contents](#)

Main Features

- 99 editable onboard sounds; many more available via the companion Editor Suite;
- Synth triggered either by an instrument's audio signal or any MIDI-capable device;
- Super-fast and accurate pitch tracking over the full range of 6-string bass or guitar;
- Ability to simultaneously trigger synthesizers via 1V/Octave analog CV or MIDI;
- Wide input and oscillator ranges - instruments of all pitches can be used;
- 4 VCOs each with saw, square (with variable pulse width) and triangle waveforms;
- ADSR envelopes for VCA and VCF, giving the ability of precise envelope shaping;
- AD envelope for the Noise source;
- 4 Flexi Controllers - a powerful real-time, user-controllable modulation matrix;
- 4 reorderable effects - EQ, Overdrive, Chorus and MIDI-synchronizable Delay;
- Resonant 12/24 dB/oct. filter with Lowpass, Highpass, Bandpass and Notch modes;
- 2nd, parallel Bandpass filter;
- Global LFO for VCOs and VCF;
- 10 additional LFOs - including saw, square, triangle and S&H types, 5 of which are MIDI-synchronizable;
- Envelopes and LFOs freely assignable via Flexi Controllers;
- Expression control of parameters via MIDI, including LFO, filter, volume and sustain;
- A 3-voice harmonizer with variable transposition on two of its voices;
- High-quality distortion for the harmonizer voices and dry input signal;
- Split Mode - only the synth signal is sent to the audio output so the input instrument signal can be split using a Y-cable or splitter box prior to the audio input socket;
- Synth and EWI Mode - audio input signal can be decoupled from the synth triggering circuit to allow independent triggering by MIDI whilst still playing your bass/guitar;
- Built-in tuner;
- Powered by a standard 9V, center-negative supply with current draw of only 200mA;
- Large 3-digit display - the current sound's location number is visible at all times;
- An exciting factory default soundset created by experienced sound designers;
- All 99 sounds accessible directly from the pedal - no external equipment required;
- Ability to transfer sounds between pedal and computer via an intuitive interface;
- Rugged and road-worthy metal housing with solid metal potentiometer shafts;
- Full-size MIDI IN and OUT ports;
- Relay-switched true bypass.

Top Panel Controls and Display



Connections



[Go to Table of Contents](#)

Quick-Start Guide

The Future Impact V4 will let you play amazing and authentic synth lines from your bass, guitar, keyboard or practically any other instrument. It features 99 onboard sounds that you can quickly shape to your taste using the [Top Panel Controls](#). By using the pedal in conjunction with its companion [Editor Suite](#) software, you can branch out further and download many more free sounds created by experienced sound designers and other enthusiasts in the music community. You can also learn to build and share your own sounds, unlocking your creative potential and opening the door to inspirational music-making.

This guide will show you how to set up and use the FI4 with your bass/guitar, including the use of the built-in Tuner. The guide will also explain what the main sound-sculpting parameters are and how to adjust them easily on the pedal.

If you want to load new sounds onto the pedal, create your own sounds, or use the FI4 to trigger a 1V/Octave analog synthesizer, then you will need to consult the [Detailed Manual](#).

There is also a very helpful [FAQ](#) section at the very end of this manual.

Setting up the Future Impact V4

Connect your bass/guitar to the INPUT socket; connect the OUTPUT socket to an amplifier.

Connect a 9V stabilized, 200mA (minimum), center-negative, Roland/Boss-type power supply to the DC 9V socket. The power supply must match the mains voltage and connector requirements of your country.

Upon powering on, the display will first show the firmware version number for one second.

Next it will show the Instrument Mode for one second - the default is bass guitar ("bSS"). (It is very important to set the correct Instrument Mode for your instrument. See the section below entitled [Setting the Instrument Mode and Resetting the Parameters](#) for details.)

Finally, the display will show the bank and program number. (These terms will be discussed in the following sections of this guide.)

Press the ON/OFF footswitch (right) to turn the FI4 on - the ON LED will light up.

Adjust the INPUT LEVEL dial so that the red LED lights up briefly only when your bass/guitar is played at its loudest; adjust the OUTPUT LEVEL dial to your needs.

Note: As the FI4 has true bypass switching, the level display will only work when the effect is ON.

[Go to Table of Contents](#)

Operating the Future Impact V4

The FI4 has 99 sounds (programs) distributed across 10 banks: bank 0 has 9 sounds, all other banks have 10. Step up through the banks by *pressing* the EDIT/BANK UP dial (**by hand only**). Press and hold this dial and turn it to quickly move up or down to any bank.

Sounds are selected with the PROGRAM footswitch. Press to move up; double-press to move down. Hold down the footswitch after pressing or double-pressing to scroll. Bank borders are ignored when using the PROGRAM footswitch. 99 wraps around to 01 and vice versa.

Playing the Future Impact V4

Although the synthesizer in the FI4 accurately tracks over the entire range of 24-fret, 6-string bass and guitar, in order to function correctly, it requires an input of cleanly-played *monophonic* notes. If you play chords or use slapping or tapping techniques, then this can result in glitching. Due care must be given to muting between subsequent notes so that the pitch-detection circuit can accurately “hear” a new pitch and a new note beginning. To a certain extent you must learn to *play the pedal*, much like you would need to learn to play *any* new instrument. Furthermore, if you try to use it outside of the pitch range of the selected Instrument Mode then unpredictable results will occur.

Important: Please select the appropriate [Instrument Mode](#) in the [Global Menu](#).

To learn how to use the FI4 to trigger external synthesizers, please see the sections on [Control Voltage \(CV\) Triggering](#) and [MIDI Triggering](#).

Tuner

The FI4 includes a very high-quality, fast-response Tuner that uses the advanced pitch detection technology of the FI4.

To activate the Tuner, press and hold the ON/OFF footswitch for 0.8 seconds¹; release as soon as the display changes.²

To deactivate the Tuner, press ON/OFF briefly and the FI4 will return to the ON state.

The Tuner can also be activated and deactivated by using its dedicated MIDI command. See the [MIDI Implementation](#) section for details.

¹ Do not hold for any longer as a press of 1.8 seconds is used when accessing the Global Menu.

² The Tuner’s display will be blank if there is no input signal.

The Tuner can be activated from both the ON and OFF states and in either case the audio output will be completely muted.

In the pedal's display, the left-hand digit shows the note name and the middle digit shows (an approximation of) the # sign. The right-hand (DATA) digit shows the fine-tune value using one or more of the three horizontal lines as follows:

DATA Digit State	Meaning
Upper line only lit	Sharp by > 10 cents
Upper and middle lines lit	Sharp by > 3 cents
Middle line only lit	In tune (within ± 3 cents)
Lower and middle lines lit	Flat by > 3 cents
Lower line only lit	Flat by > 10 cents

The Tuner is calibrated to the Tune Base value. This can be adjusted in the range of 428-452 Hz. (The default value is 440 Hz). See the [Global Menu](#) for instructions on how to set the Tune Base.

Note 1: If the [Sustain](#) feature is active when engaging the Tuner, the display will show the value of the sustained synth pitch and won't respond to instrument input. Disengage the Sustain to allow the Tuner to function normally.

Note 2: When the Tuner is engaged, the Program footswitch (or its [corresponding MIDI command](#)) can be used to set the [Tap Tempo](#) for the [Delay](#) effect.

Editing the Sounds and the Playing Response

You can edit nine *per-program* sound parameters directly on the pedal via the [Top Panel Controls](#) and save the changes.

There are also two *global* parameters which affect the playing response.

All the parameters are explained [further below](#).

Most parameters have a maximum adjustment range of -64 to 63 (though this is occasionally smaller) and a default value of 0.

Select a parameter using the PARAMETER dial; turn the EDIT dial to see and edit its value.

Edits to the two *global* parameters are saved automatically.

[Go to Table of Contents](#)

Editing a *sound* parameter causes an immediate audible change and a blinking decimal point indicates an unsaved edit; press the EDIT dial to save.

Any unsaved edits will be lost when adjusting one of the two *global* parameters, switching to a new program, pressing the ON/OFF footswitch or powering off.

If the PARAMETER dial is pointing at one of the nine sound parameters and the display is showing the program number, then the DATA digit will show you if any of the sound parameters have been edited. How it does this is shown in the following table:

DATA Digit State	Meaning
Blank	All nine parameters are unedited.
Upper horizontal line lit	The parameter has been edited using a positive value.
Lower horizontal line lit	The parameter has been edited using a negative value.
Middle horizontal line lit	The parameter is unedited, but one or more of the other eight parameters has been edited.

Important: Knowing whether or not any sound parameters have been edited is vital if you wish to transfer the program files from the pedal to your computer. This is because these saved edits do not alter the original program file data, they merely apply a temporary offset to the data. If you want the programs you transfer to the computer to sound exactly the way they do after having been edited, you must first write these parameter edits into the program file.

Writing Parameter Edits into the Program File

To permanently overwrite the program data with the current settings, first save the edits as normal so that the decimal point stops blinking.

Press and hold the EDIT dial for three seconds and release when the program number begins blinking. At this point you can either cancel or write the edits to the program.

To cancel, press either of the footswitches or *turn* the EDIT dial.

To write the edits, press the EDIT dial. The program number will blink once to confirm. The program's filename will be appended with “#” to indicate that it differs from the original file. The PARAMETER dial values will be reset to 0.

Parameter Descriptions

NOTE OFF LEVEL (global): Sets the volume threshold of the input signal below which the synth stops sounding. A lower value allows you to sustain notes longer. A higher value allows better articulation of staccato notes.

NOTE ON LEVEL (global): Sets the volume threshold of the input signal above which the synth begins sounding. If low-volume notes do not trigger the synth then decrease the value. If multiple triggering occurs then increase the value.

ATTACK: Sets the length of the attack stage of the filter AD/ADSR envelope. Higher values make the filter take longer to open after a note is played.

DECAY: Sets the length of the decay stage of the filter AD/ADSR envelope. Higher values make the filter take longer to close again after it has opened.

ENVELOPE DEPTH: Sets how much the filter opens in response to the filter AD/ADSR envelope.

DYNAMICS: Sets how much the filter opens in response to playing dynamics. If Instrument Mode is set to Bass, Split or Guitar, then Dynamics controls the Envelope Follower; if set to Synth or EWI then it instead controls the Accent parameter (MIDI note velocity).

CUTOFF: Sets the cutoff frequency of the filter. Lower values yield a darker sound; higher values yield a brighter sound.

RESONANCE: Boosts the frequencies around the filter cutoff frequency. Lower values give a flat, wide peak; higher values give a narrow, sharp peak.

BALANCE: Sets the balance between the bass/guitar sound and the synth sound. Setting this to maximum mutes the dry bass/guitar sound entirely.

LEVEL: Sets the overall output level of the sound.

EFFECTS: Sets the amount of chorus, delay, overdrive or tilt-EQ applied to the sound. For full details on how the effects are influenced by this parameter see the [explanation](#) at the very end of the [Effects Block](#) section of this manual.

Choosing the Startup Sound

The F14 always starts up at the program most recently saved using the EDIT dial.

Navigate to the program you want to have as the startup sound using the PROGRAM footswitch or your MIDI controller.

Point the PARAMETER dial at one of the sound parameters.

Turn the EDIT dial one click in any direction so the parameter value is displayed; before the display reverts, turn the EDIT dial one click in any direction then one click in the other direction.

Press the EDIT dial to save.

Note: If you subsequently edit another program's parameters with the EDIT dial and save the changes, then that program will become the new startup program.

Setting the Instrument Mode and Resetting the Parameters

Both of these tasks are accomplished using the [Global Menu](#). (The Global Menu actually contains eleven items but we'll only deal with the first two now.)

There are two ways to enter the Global Menu:

- **Standard Method** - Press and hold the PROGRAM (left) footswitch while powering on. Release after the Global Menu splash screen ("GLb") has disappeared.
- **Quick Method** - If the pedal is already powered on, press the ON/OFF (right) footswitch for 1.8 seconds. Release when "GLb" is shown in the display. Now press the PROGRAM (left) footswitch to enter the menu (or press ON/OFF to cancel).

Turn the PARAMETER dial to "Note Off Level" to show the menu item's name; turn the dial to any other position to show its value. Adjust the value by turning the EDIT dial.

Press the PROGRAM footswitch again to move to the next menu item and edit it as before.

When you have finished editing, either press the ON/OFF footswitch or power cycle for the changes to take effect. (When using the ON/OFF footswitch, the firmware version splash screen is skipped and the selected Instrument Mode is shown while ON/OFF is held down.)

- **INSTRUMENT MODE ("InS")**
Value: bSS (Bass), SPL (Split), Gtr (Guitar), Snt (Synth), EUI (EWI). (Default on reset is bSS.)

[Go to Table of Contents](#)

To trigger the FI4's synthesizer via the audio input from any pitched instrument, select Bass or Guitar. If your instrument is neither of these, choose whichever option best fits its pitch range. (Split is a variant of Bass mode and will be explained later.)

To trigger the FI4's synthesizer via MIDI, select Synth or EWI.

In any Instrument Mode you can also trigger an external analog synth via the 1V/Octave [CV](#) and Gate outputs using an optional adapter cable.

See the [Instrument Modes](#) section below for full details of the different modes.

- **RESET ALL ("rS")**

Value: 0, 1. (Default on reset is 0.)

Change to "1" to *immediately* reset all Global Menu and PARAMETER dial settings to their default values. The startup program will be reset to 01.

A Quick Word About Firmware

In order to enjoy all the latest features of your FI4 you should ensure you have the latest firmware version installed: check the number shown in your pedal's display when powering on. Please see the dedicated section on [Updating the Firmware of the Future Impact V4](#).

Detailed Manual

The opening section of this part of the User Guide will explain the settings of the FI4's [Global Menu](#), including its different [Instrument Modes](#). It will then show you how to configure the [CV Triggering](#) and [MIDI Triggering](#) functions and how to [update your pedal's firmware](#).

The next few sections, which form the bulk of the manual, will show you everything you need to know about the [Editor Suite](#). They begin by showing you how to download and install the software and connect the FI4 to your computer. They then go on to explain how to load, save, transfer and rearrange programs using the [Manager](#). The final section of that group takes you through all of the controls and functions of the [Editor](#) in detail. Immediately after that, there is a section on [Building Your First Sound](#) from scratch, followed by some short [Tutorials](#) on how to configure the FI4 to replace single-effect stomp boxes.

Towards the end of the manual there is a section which explains the [MIDI](#) features of the FI4 such as [Expression](#) control and the [Sustain](#) feature. There is a chart showing the full [MIDI Implementation](#).

The [Appendix](#) contains block diagrams of the FI4's signal path and some useful lookup tables of the filter and LFO frequency settings.

A tremendous amount of care and effort has been put into making this manual as clear, comprehensive and user-friendly as possible. As you will have already noticed, there are hyperlinks throughout the document. At the bottom of each page there is a hyperlink to the Table Of Contents (which itself comprises hyperlinks) so you can click to quickly navigate between sections if you need to refer to relevant information discussed elsewhere. Should you be unable to find what you are looking for in the Table Of Contents, remember that you are most likely reading this in PDF format either online or embedded in the Editor Suite; as such, you can press CTRL+F and type a keyword to find the information you need.

The FI4 is a very deep pedal and there is a lot to learn. You will probably need to refer back to this manual several times. It really does contain a wealth of information and if you take the time to read and digest it, you will be rewarded with the knowledge of how to create some amazing sounds.

We hope that your Future Impact V4 brings you many years of joyful music-making!



The Panda Team

[Go to Table of Contents](#)

The Global Menu

From here you can set the Instrument Mode, reset all hardware parameters, set the FI4's MIDI channel, set the range of the filter, set the Tune Base, turn MIDI Thru on or off, and access all the CV-related settings.

There are two ways to enter the Global Menu:

- **Standard method** - Press and hold the PROGRAM (left) footswitch while powering on. Release after the Global Menu splash screen (“**GLb**”) has disappeared.
- **Quick method** - If the pedal is already powered on, press the ON/OFF (right) footswitch for 1.8 seconds. Release when “**GLb**” is shown in the display. Now press the PROGRAM (left) footswitch to enter the menu (or press ON/OFF to cancel).

Turn the PARAMETER dial to “Note Off Level” to show the menu item's name; turn the dial to any other position to show its value. Adjust the value by turning the EDIT dial.

Press the left footswitch again to move to the next menu item and edit it as before.

When you have finished editing, either press the ON/OFF footswitch or power cycle for the changes to take effect. (When using the ON/OFF footswitch, the firmware version splash screen is skipped and the selected Instrument Mode is shown while ON/OFF is held down.)

- **INSTRUMENT MODE (“InS”)**
Value: bSS (Bass), SPL (Split), Gtr (Guitar), Snt (Synth), EUI (EWI). (Default on reset is bSS.)

To trigger the FI4's synthesizer via the audio input from any pitched instrument, select Bass or Guitar. If your instrument is neither of these, choose whichever option best fits its pitch range. (Split is a variant of Bass mode and will be explained later.)

To trigger the FI4's synthesizer via MIDI, select Synth or EWI.

In any Instrument Mode you can also trigger an external analog synth via the 1V/Octave [CV](#) and Gate outputs using an optional adapter cable.

See the [Instrument Modes](#) section below for full details of the different modes.

- **RESET ALL (“rS”)**
Value: 0, 1. (Default on reset is 0.)

Change to “1” to *immediately* reset all Global Menu and PARAMETER dial settings to their default values. The startup program will be reset to 01.

- **MIDI CHANNEL (“CHA”)**

Value: ALL, 1-16. (Default on reset is ALL.)

When set to “ALL”, the FI4 will respond to messages received on all 16 channels. However, when sending out Program Changes and MIDI note messages, it will do so on channel 1 only.

When set to a number between 1 and 16, the FI4 will only respond to messages received on that channel. It will also send out Program Changes and MIDI note messages on that channel only.

- **VCF CONTROL RANGE (“uCF”)**

Value: 1 (± 1 octave), 2 (± 2 octaves), 4 (± 4 octaves). (Default on reset is 1.)

Sets the Voltage-Controlled Filter (VCF) control adjustment range used when the VCF frequency is controlled by MIDI CC11 or CC74. The center point of the range corresponds to the program’s preset cutoff value (as set by the [VCF FRQ](#) slider in the [Editor](#)).

- **TUNE BASE (“tBS”)**

Value: 428-452 (Hz). (Default on reset is 440.)

This sets the tuning of the synthesizer when it is triggered using the MIDI IN. (Triggering the synthesizer using the audio input is *not* affected by this parameter as the tuning of the synthesizer is *always* locked to the pitch of the audio input signal.)

This also sets the base of the [Tuner](#).

- **MIDI THRU (“trU”)**

Value: OFF, on (Default on reset is OFF.)

If set to “OFF” then MIDI information received via MIDI IN will *not* be passed to MIDI OUT.

If set to “on” then all information received via MIDI IN *will* be passed to MIDI OUT (with the exception of CC6 (Data Edit), NRPN controllers and SysEx data).

- **OUTPUT MODE (“OUt”)**

Value: A C (Audio & CV), A (Audio only), C (CV only) (Default on reset is A C.)

This option chooses which signals (digital audio or Control Voltage) will be output when the FI4 is engaged. These signals are not output when the FI4 is disengaged.

- **CV SCALE (“CuS”)**

Value: -64...0...63. (Default on reset is 0.)

This allows an overall adjustment of $\pm 3\%$ to the octave scaling of the entire 0-5V CV range, which equates to approximately ± 50 cents per octave. See the section on [CV Calibration](#) below for details.

- **CV FINE OFFSET (“CuF”)**

Value: -64...0...63. (Default on reset is 0.)

This allows an overall adjustment of $\pm 6\%$ to the semitone tuning of the entire 0-5V CV range, which equates to approximately ± 1 semitone. See the section on [CV Calibration](#) below for details.

- **CV SEMITONE OFFSET (“SEt”)**

Value: C, C#, D, D#, E, F, F#, G, G#, A, A#, B. (Default on reset is C.)

This is used to match the FI4’s pitch output to that of your synth. If an exact integer voltage value (0V, 1V, 2V, etc.) generates any note other than C on the synth, select the name of the note that *is* produced at that voltage here. For example, if 0V generates an A on your synth, then set CV Semitone Offset to A.

- **CV OCTAVE OFFSET (“OCT”)**

Value: 0, 1, 2 (Default on reset is 1.)

This parameter determines which input pitches will generate the CV levels of the 0-5V range. You can use this parameter to ensure that the pitch of the input instrument and the pitch of the external synth play at the exact same frequency.

The CV levels generated at the various octave settings are summarized in the table below.³

Octave Offset	0V generated by		5V generated by	
0	C0	16 Hz	C5	523 Hz
1	C1	32 Hz	C6	1046 Hz
2	C2	65 Hz	C7	2093 Hz

³ The values shown are for when the CV Semitone Offset parameter is set to its default of “C”.

The Instrument Modes

In order to get the best performance from the FI4, it is very important to set the correct Instrument Mode for your instrument. If your non-MIDI instrument is not among those listed below then choose either Bass or Guitar, whichever one best fits its range. (Bass is the default setting.)

The Instrument Mode is set via the [Global Menu](#).

Bass Mode

The synthesizer is triggered by the audio input. The pitch tracking is optimized for (and limited to) the entire range of a 24-fret, 6-string bass guitar.

Split Mode

A variation of Bass mode, designed for using the FI4 on stage with two separate amplifiers (one for bass/guitar, one for synth), or for using in the studio where having separate bass/guitar and synth channels may be desired. In this mode you must split the signal prior to the FI4's input with a splitter box or a Y cable for the two destinations.

Everything works as in Bass mode, but with the following differences:

- The direct audio signal portion of all programs is muted so that only the synth⁴ signal is sent to the FI4's audio output;
- The ON/OFF footswitch will not switch to true bypass when turned off; instead the output remains connected to the digital circuitry and all signals are muted.

Guitar Mode

The synthesizer is triggered by the audio input. The pitch tracking is optimized for (and limited to) the range of a 24-fret, 6-string guitar.

Synth Mode and EWI Mode

These two modes are for playing the FI4 solely via a MIDI controller. Both modes are identical except for the initialization of MIDI CC values. (See the table on the next page.) The FI4's audio input is decoupled from the pitch-detection circuit and all envelope triggering. Your instrument's audio signal can still be routed through the [VCF Block](#) and the [Effects Block](#), but the envelopes and synthesizer notes will *only* be triggered via the MIDI input.

⁴ Here by "synth" we mean the contents of the VCF output, that is, *any* signal routed through the filter.

Note: The [Distortion Block](#) cannot be used.

Unlike in Bass/Split/Guitar modes, the FI4 will power on in the ON state.

The [Tuner](#) has no function.

MIDI CC initialization values in all Instrument Modes:

		MIDI CC								
		1	2	5	7	11	64	65	74	92
Mode	Bass/Split/Guitar	127	127	127	127	64	0	127	64	127
	Synth	0	127	127	127	64	0	127	64	127
	EWI	127	127	0	127	64	0	127	64	127

Note: These MIDI CCs will be initialized to their default values on startup, on every program change and whenever the Editor changes a Flexi source.

Control Voltage (CV) Triggering

One of the FI4's new features is its ability to trigger an external analog synthesizer using CV signals. This can be done in any Instrument Mode. To do this, you will need to connect the optional adapter cable to the MIDI OUT port. The cable duplicates the function of the MIDI port and provides two further cables, one for 1V/Octave CV and one for 5V/3.3V Gate.

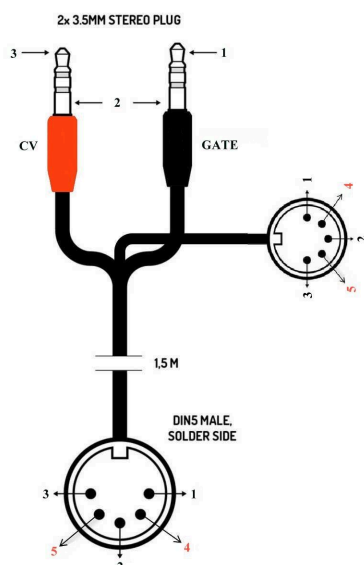

Connect the CV cable (red plug) to the 1V/Oct pitch input of your synthesizer. Connect the Gate cable (black plug) to the gate input of your synthesizer. Note that some synthesizers have separate gate inputs for the VCA and VCF envelopes, in which case you will need to use a hub or splitter cable attached to the gate cable to send the signal to both destinations.

You will need to match the tuning of your external synthesizer to that of the instrument you are using to trigger it (and hence to that of the FI4). For that, it may be necessary to calibrate the CV signals sent out from the FI4. (Both audio and CV signals can be enabled and disabled using Output Mode (**Out**) in the [Global Menu](#).)

[Go to Table of Contents](#)

CV Calibration

Calibration is done using the CV Scale and CV Fine Offset parameters found in the [Global Menu](#).

Calibration is *not* done using your instrument, but instead by sending test voltages from the FI4. The position of the PARAMETER dial sets the voltage as shown in the table below:

PARAMETER dial position	CV
Note Off Level ⁵ & Note On Level	0V
Attack	1V
Decay	2V
Env Depth	3V
Dynamics	4V
Cutoff, Resonance, Balance, Level, Effect	5V

The recommended method for calibration is as follows:

1. Enter the [Global Menu](#) and navigate to CV Octave Offset (**Oct**) and set it to “0”;
2. Navigate to CV Semitone Offset (**SEt**) and set it to “C”.
3. Gate your external synthesizer on. Typically this is done using a dedicated gate/drone switch, by turning up the VCA, or sometimes by disabling the VCA entirely. (You may also need to set the VCF cutoff high in order to hear sound.)

If your external synthesizer is unable to be manually gated on, press the FI4’s EDIT dial to toggle a gate signal on and off. (This will automatically gate off when switching to the next Global Menu item or when exiting the menu.)

4. Navigate to CV Scale (**CuS**). Turn the PARAMETER dial to “Note On Level” (0V). If you have a reference instrument, adjust the pitch of the synthesizer to be as close as possible to the reference note. Alternatively tune the synthesizer to an exact note on a tuner.
5. Turn the PARAMETER dial to Attack (1V). You should hear a note that is one octave higher than before. If it sounds flat, turn the EDIT dial clockwise to raise the pitch. By

⁵ Remember that in the Global Menu, when the PARAMETER dial is pointing to Note Off Level, the menu parameter’s *name* is displayed; in any other position of the dial, the parameter’s *value* is displayed.

contrast, if it sounds sharp, turn the EDIT dial counterclockwise to lower the pitch.

6. Turn the PARAMETER dial back to Note On Level (0V). If it sounds out of tune, then tune the synthesizer to the reference note again. Repeat steps 4 and 5 until the pitch is in tune in both octaves.
7. Once both octaves are in tune, check to see that the tuning is also correct at the higher voltage settings (2V-5V). If not, make further adjustments.
8. Most likely you can tune your synthesizer's oscillator(s) using its own potentiometers. Once CV Scale has been set correctly, you can start to play your instrument and just tune the synthesizer to match its pitch.
9. If for any reason you cannot tune your synthesizer to the FI4, then navigate to CV Semitone Offset (**Set**). If playing a C on your instrument generates any note other than C on the synthesizer, select the name of the note that *is* produced here. For example, if C on your instrument generates an A on your synth, then set CV Semitone Offset to A.
10. If you need to fine tune your synthesizer to the FI4, then it is easiest to do that on the synthesizer itself. However, if that isn't an option, then you can use CV Fine Offset (**CuF**) to adjust it within a range of approximately ± 1 semitone.

MIDI Triggering

New for v4.11 is the much-requested ability to use the FI4 to convert audio signals from the input into MIDI note data in order to trigger an external MIDI synthesizer. This can be done in Bass, Split and Guitar Instrument Modes.

To get started, connect the MIDI output port of the FI4 to the MIDI input port of your synthesizer.

The FI4 sends the generated MIDI data using its own channel, therefore you must set the MIDI channel on the external synthesizer to the same channel as the FI4. (The FI4's MIDI channel is set via the [Global Menu](#).)

Now engage the pedal and select an FI4 program that has MIDI Triggering enabled.

(The section on the [External MIDI Tab](#) in the [MIDI Block](#) contains a full description of all the settings used when triggering external synths from the audio input via MIDI.)

The first four programs of the v4.11 factory sound set have MIDI Triggering enabled by default so that you can try out the feature without having to use the Editor. They are set up

with various PC, octave transposition and pitch bend settings, as shown in the following table:

FI Program	PC	General MIDI Name	PBD Range	TRANSP
1	52	Choir Aahs	0	0
2	38	SynthBass1	2	-1
3	72	Piccolo	7	+2
4	71	Clarinet	12	+1

In order for MIDI triggering to function correctly, the pitch bend amount on your external synthesizer must be set to the same value as the pitch bend in the FI4 program (adjusted via the [External MIDI Tab](#) of the [MIDI Block](#) of the Editor). This is essential for using pitch bend to correct any pitch detection errors and to interpret playing techniques such as hammer-ons and pull-offs. For best results, use the maximum pitch bend that your synthesizer allows (whilst ensuring it still matches the FI4's own setting). If your synthesizer has separate values for pitch bend up and down, these must be set to the same value as each other.

Bear in mind that on some synthesizers the pitch bend setting is global whereas on others it is per-preset. The most common (non-zero) settings are 2, 7 and 12 semitones.

It should be possible to work out (and in most cases, alter) which pitch bend value your synthesizer is currently using by referring to its display or settings menu.

Alternatively, you can work out its pitch bend value by moving the pitch bend wheel/lever to maximum, playing an A and listening to which actual note is produced. For example, if you play an A and a C is heard, the pitch bend value is 3 semitones.

If your synthesizer does not have a physical pitch bend controller or if its pitch bend value cannot be altered, you can use the following method to check which pitch bend range is in use and match it in the [Editor](#):

1. Set the PBD RANGE slider in the Editor to 7;
2. Play the G on the 5th fret of the D string of your bass, then hammer-on (without plucking the string) to the A two frets higher.
3. If the settings are correctly matched then you will get an in-tune A with no retriggering of the attack of the note. If this does not happen, move on to the next step;
4. If the hammer-on produces a note that is higher than A, decrease the PBD RANGE value in the Editor and repeat step 2, otherwise move on to the next step;

5. If the hammer-on produces a note that is lower than A, increase the PBD RANGE value in the Editor and repeat step 2.

Using a pitch bend setting of 0 in the Editor is far better than having mismatched values between the FI4 and the external synthesizer. At a setting of 0, a hammer-on or pull-off will be interpreted as a new note trigger.

Note: If [MIDI Thru](#) is enabled, any MIDI CC messages intended for the FI4 will also be sent on to (and potentially affect) the external synthesizer. If you only want to control things like modulation, [Expression](#) and [Sustain](#) on the FI4 but not on the external synthesizer, then you must disable MIDI Thru in the [Global Menu](#).

When changing presets on the FI4 using the PROGRAM footswitch, the EDIT/BANK UP dial or MIDI CC messages⁶, then the following occurs:

- If the MIDI OUT slider in the [External MIDI Tab](#) is set to OFF, then the FI4 will send out the PC number of the currently-selected FI4 patch;
- If the MIDI OUT slider is set to ON, then the FI4 will send out the PC number as set by the PC slider in the [External MIDI Tab](#).

When changing presets on the FI4 by sending a PC message, then the following occurs:

- If the MIDI OUT slider in the [External MIDI Tab](#) is set to ON, then the FI4 will send out the PC number as set by the PC slider in the External MIDI tab;
- If the MIDI OUT slider is set to OFF and [MIDI Thru](#) is enabled, then the FI4 will pass on the incoming PC number to the MIDI Out port;
- If the MIDI OUT slider is set to OFF and MIDI Thru is disabled, then the FI4 will not send out any PC message at all.

Note: When the FI4 sends patch change information to the external synthesizer, it only sends standard PC messages; it does not send Bank Select messages. Therefore, if your external synthesizer has more than 128 presets (i.e. a preset structure that makes use of Bank Select messages), then you'll need to ensure that the external patches you intend to use with the FI4 are situated within an accessible PC range. (For example, some synthesizers that have 200 patches are arranged in 5 banks of 40 patches; these are accessed using PCs 0-39 within a given bank.) Alternatively, you could manually switch banks on the external synthesizer or send Bank Select messages to it from an external MIDI controller.

⁶ See the [MIDI Implementation](#) chart for the dedicated FI4 MIDI CC messages for Program Up/Down and Bank Up/Down.

Updating the Firmware of the Future Impact V4

You should always make sure the latest firmware version is installed on your FI4.

Check the firmware version number shown in your pedal's display when powering on.

You can update the FI4 unit's firmware to the latest version directly in your web browser (Chrome only) by going to <https://auraplug.com/fiupdate4/start.html> and following the on-screen instructions.

The online updater also gives you the option to write the latest default factory soundset to your pedal after the firmware has been installed, should you wish to do so. We strongly recommend you install the v4.11 factory sound set so that you can take advantage of the new [MIDI Triggering](#) feature which is enabled by default on the first four programs.

(An alternative way to update your pedal's firmware via the [Editor Suite](#) is detailed in the section on the [File Menu](#).)

In contrast to previous versions of the Future Impact, the firmware can now be updated using *any* MIDI interface. This means that firmware update failures should be rare.

By far the most common cause of firmware update failure is due to the MIDI cables having been mistakenly plugged into the opposite ports. The next most common cause is not having switched the FI4 into update mode. Check these things and try again.

A firmware update failure will not harm the FI4; it will still work just as before with the existing firmware. Even if power is interrupted during a firmware update, do not worry, the update process has built-in protective measures. Although the device may look dead in such a case, you can simply repeat the firmware update process again until it is successful.

The Future Impact V4 Editor Suite



The F14 Editor Suite is where all the magic happens. It can best be thought of as the control room of the pedal. If you want to move beyond the 99 onboard sounds and fully immerse yourself in the fascinating world of subtractive synthesis then this is where to do that.

The F14 Editor Suite is actually divided into two main functional views:

- **Manager:** (Shown above left.) Use this to browse and audition existing programs on your computer or online and to transfer programs between your computer and the F14;
- **Editor:** (Shown above right.) Use this to edit existing programs to your taste or create your own sounds from scratch.

You can freely switch between the two views using the tabs in the [Menu Bar](#) situated along the top of the window. (The Editor Suite always opens at the most-recently-used view.)

Both views allow you to load and save program files, albeit in slightly different ways. The differing ways are explained in the dedicated sections for each view.

If you simply want to audition new sounds created by others and load them onto your pedal, or change the order of your pedal's sounds, first connect your F14 to your computer as shown on the following page, then go straight to the section on the [Manager](#) further below.

If you want to edit sounds or create your own then you will need to use the [Editor](#)⁷. Study the various blocks of the [Editor Parameters](#) section. There is a lot of information there so you may need to keep referring back to it until you have a firm grasp. The sections are laid out clearly, logically and with examples where necessary, so this should hopefully help you to digest the information more easily. (The [Building Your First Sound](#) and [Tutorials](#) sections will further help with this.)

⁷ The Editor is **not** a VST; it produces no sound by itself. You must connect the F14 to hear any sound.

Installing the Future Impact V4 Editor Suite

Go to <http://pandamidi.com/support> and download the latest FI4 Editor Suite software package. Once you have downloaded it, locate it on your computer.

- **Windows:** Unzip the downloaded folder then double-click **FIEditor411Setup.exe** and follow the on-screen instructions.
- **Mac:** Open the file **FIEditor411.dmg** *either* by double-clicking it *or* by right-clicking it and choosing **Open With>Disk Image Mounter** from the pop-up menu. Once the DMG file has been verified, it will open automatically. Now drag the **FIEditor4** program into the Applications folder.

Connecting to the Future Impact V4 Editor Suite

Connect your interface to your computer and launch the Editor Suite. In the [Menu Bar](#) at the top of the screen, click **MIDI>Preferences** to open the MIDI Device Settings box.

Select your interface from both the **FI Input Device** and the **Output Device** drop-down menus on the left-hand side of the box. (All MIDI Device Settings are explained below.)

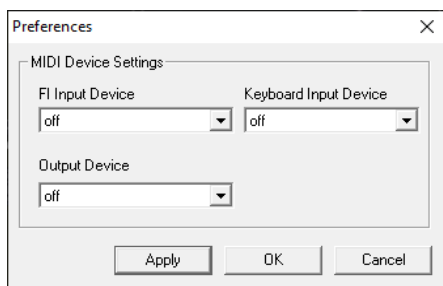

Connect your FI4 to your computer as follows:

1. MIDI OUT of the interface → MIDI IN of the FI4;
2. MIDI OUT of the FI4 → MIDI IN of the interface.

- **Output Device:** The device the Editor Suite uses to *send* MIDI data to the FI4.⁸
- **FI Input Device:** The device the Editor Suite uses to *receive* MIDI data *from* the FI4.⁹
- **Keyboard Input Device:** A second input into the Editor Suite. If you want to design a sound for use in SYNTH or EWI mode using a MIDI keyboard or any other MIDI controller, connect the MIDI OUT of the keyboard or controller to the computer using this option; the Editor Suite will pass the incoming MIDI signals through to the FI4.¹⁰

⁸ *Essential connection.* Required for auditioning, editing and creating sounds.

⁹ *Optional connection.* Required only for writing sounds to the FI4 and for downloading sounds from it.

¹⁰ This option *can* be used in the other instrument modes too, but with limited functionality such that notes on the keyboard or controller can only be played non-legato (similar to the [on-screen keyboard](#)).

Important: The FI4's MIDI OUT must only ever be connected to the computer's MIDI IN using the **FI Input Device** option. If you were to connect the FI4's MIDI OUT to the computer's MIDI IN using the **Keyboard Input Device** option then that input device's MIDI Thru feature would cause an infinite MIDI loop.

Using midiBeam 4Control with the Editor Suite

When using our midiBeam 4Control as a MIDI interface to connect to the FI4's Editor, the MIDI signals from any [expression pedals](#) and switches plugged into 4Control will be passed directly to the FI4.¹¹ This function is automatically enabled when launching the Editor, provided that 4Control was selected when the Editor was last closed. It is also enabled whenever you select 4Control as the Output Device in the **MIDI>Preferences** menu and press **OK**. (Please see the [midiBeam 4Control User Manual](#) for full details.)

The Menu Bar

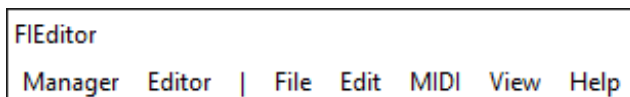

Here you can find the tabs for switching between the [Manager](#) and [Editor](#) views. It is also home to menu functions which apply to both the Manager and the Editor (except where indicated otherwise). We have already covered the items found in the [MIDI Menu](#) in the section above; the remaining items are explained below.

The File Menu

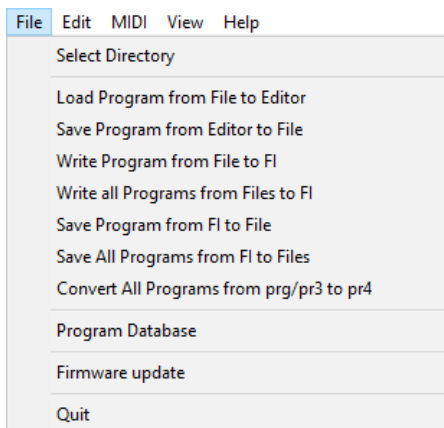

¹¹ Requires 4Control firmware v1.4 and above.

The options in this menu are as follows:

- **Select Directory:** Specifies the location that the [Editor](#) uses for loading and saving program files. (Note that this option has no function in the Manager.)
- **Load Program from File to Editor:** Loads a program from your computer into the Editor. The FI4 Editor can load program files that were created with a pre-V4 Editor (*.prg, *.pr3), *but will convert these to the current format (*.pr4) when saving.*¹²
- **Save Program from Editor to File:** Saves an edited program to your computer.

You can save a program to your computer using any name **up to 32 characters in length**. (In order to write a program to the FI4, the name *must* begin with a two-digit prefix between 01 and 99. This prefix determines the slot on the FI4 to which the program will be written. When using the **Upload to FI** function of the [Manager](#) to write programs, this prefix is added automatically.)

- **Write Program from File to FI:** Opens the selected directory and allows you to select one sound program and write it to the FI4.

Remember, the program must have a two-digit prefix at the beginning of its name before it can be written. If it does not, either add one by renaming it, or easier still, use the **Upload to FI** function of the [Manager](#) and the prefix will be added automatically. We recommend using the Manager to write programs to the FI4.

Note: Whilst the **Write Program from File to FI** command may appear to work even if you only have one cable connecting the computer to the FI4, the Editor Suite will not receive confirmation of the writing action and an error message will appear; *both* cables must be used.

- **Write All Programs from Files to FI:** Writes all programs from your selected directory to the FI4 in a single run.

When you use this option you must have a bi-directional connection between the FI4 and the computer, otherwise an error will occur after writing the first program.

If the directory contains two or more files that have the same two-digit prefix then you will receive an error message and the write process will not be possible until you have removed the duplicates.

If the directory contains gaps, i.e. if any of the two-digit prefixes between 01 and 99 are not included in the list of program file names, then you will be presented with two options (**the second of which is the one you are most likely to want to use**):

¹² Please see the footnotes of the **Accent** parameter description located near the end of the [Filter](#) section which concern the compatibility of .prg- and .pr3-format programs.

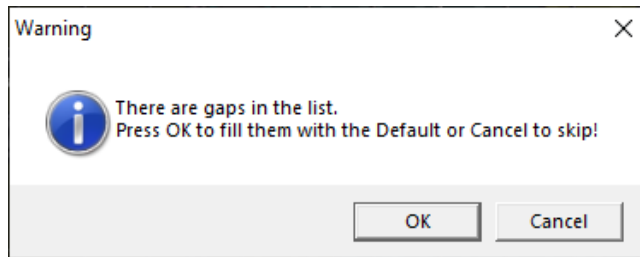

1. Press **OK** to **fill the gaps with the Default** - the slots in the FI4 corresponding to the gaps will be **overwritten** with the *lowest-numbered program in the directory*;
 2. Press **Cancel** to **skip the gaps** - the slots in the FI4 corresponding to the gaps will be **ignored** and the *original programs in those slots will be untouched*.
- **Save Program from FI to File:** Allows you to save a single program from the FI4 to your computer.

Important: Any edits to a program's parameters made on the pedal using the PARAMETER and EDIT dials must be [written into the program file](#) before attempting to transfer the programs to your computer, otherwise they will not play back as expected when opened in the Editor or loaded back onto the pedal.

- **Save All Programs from FI to Files:** Allows you to save all 99 programs from the FI4 to your computer.

Note: Programs store the 32 characters of the filename; when you save a program from your FI4 to your computer, the Editor will suggest the original name of the file by default.

- **Convert All Programs from prg/pr3 to pr4:** Converts a whole folder of older-format program files to the current format.¹³ The new files will appear in the same folder.
- **Program Database:** Clicking here will launch a web browser and take you to our [dedicated sound-sharing website](#) where you can listen to and download sounds from other users and upload sounds of your own. However, all the programs hosted on the Program Database are accessible directly within the [Manager](#).
- **Firmware Update:** Offers an alternate to the [recommended browser-based FI4 firmware update method](#).

Download the latest firmware file (**FI4xx.fi4**) from <http://pandamidi.com/support>, then follow the steps below to install the update:

¹³ Please see the footnotes of the **Accent** parameter description located near the end of the [Filter](#) section which concern the compatibility of .prg- and .pr3-format programs.

1. Connect a MIDI interface to the PC, then connect the FI4 to the interface as follows:
 - MIDI interface MIDI OUT (assigned to Output Device) → FI4 MIDI IN;
 - FI4 MIDI OUT → MIDI interface MIDI IN (assigned to FI4 Input Device).
2. Power on the FI4 while keeping both footswitches pressed. The ON LED will start slowly blinking; all other LEDs and displays will be unlit;
3. Click **Firmware Update** and select the update file.

If the FI4 is not detected, “Future Impact not present” will be displayed.

If the FI4 *is* detected then the update will commence: “Erasing flash memory” will be displayed, followed by “Firmware Update Process: 0%” and the LED will blink more quickly.

When the progress indicator reaches 100%, which should take around 80 seconds, “Update successful!” will be displayed and the LED will go back to blinking slowly.

If there is a problem during the update the Editor Suite will display “Error!” and the update will be stopped - the LED might be on, off or blinking quickly.

After a successful update, power the FI4 off and on again. Check that the version number which appears on the display is the same as the number of the update file. You can now start to use the FI4.

If the update was unsuccessful then see the section on [Updating the Firmware of the Future Impact V4](#).

- **Quit:** Closes the FI4 Editor Suite.

The Edit Menu

Edit	
Undo	Ctrl+Z
Redo	Ctrl+Y

Here there are options to **Undo** or **Redo** any parameter changes made while editing a sound in the Editor. The two functions can also be carried out by pressing **CTRL+Z** or **CTRL+Y** respectively.

Note: The Edit Menu has no function when the Manager view is active.

[Go to Table of Contents](#)

The View Menu

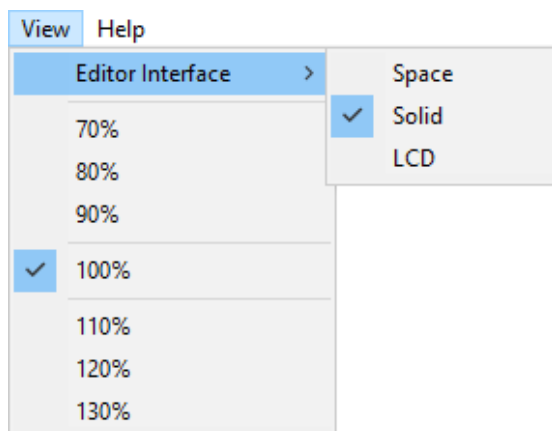

The size of the Editor Suite window can be chosen here. (The window can also be resized by left-clicking and dragging the lower-right corner.)

The **Editor Interface** sub-menu offers three options:

- **Space** is the classic skin (shown [here](#));
- **Solid** is the classic skin but without the space-themed background (shown [here](#));
- **LCD** is a photorealistic skin (shown [here](#)).

Note: Switching between the classic and LCD skins requires the Editor Suite to be restarted. Save any edits you have made before switching otherwise they will be lost.

The Help Menu

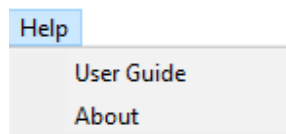

An embedded version of this **User Guide** can be accessed [here](#); it will launch in a web browser.

About will display the version number of the Editor Suite and other information about the FI4 and its creators.

The Manager

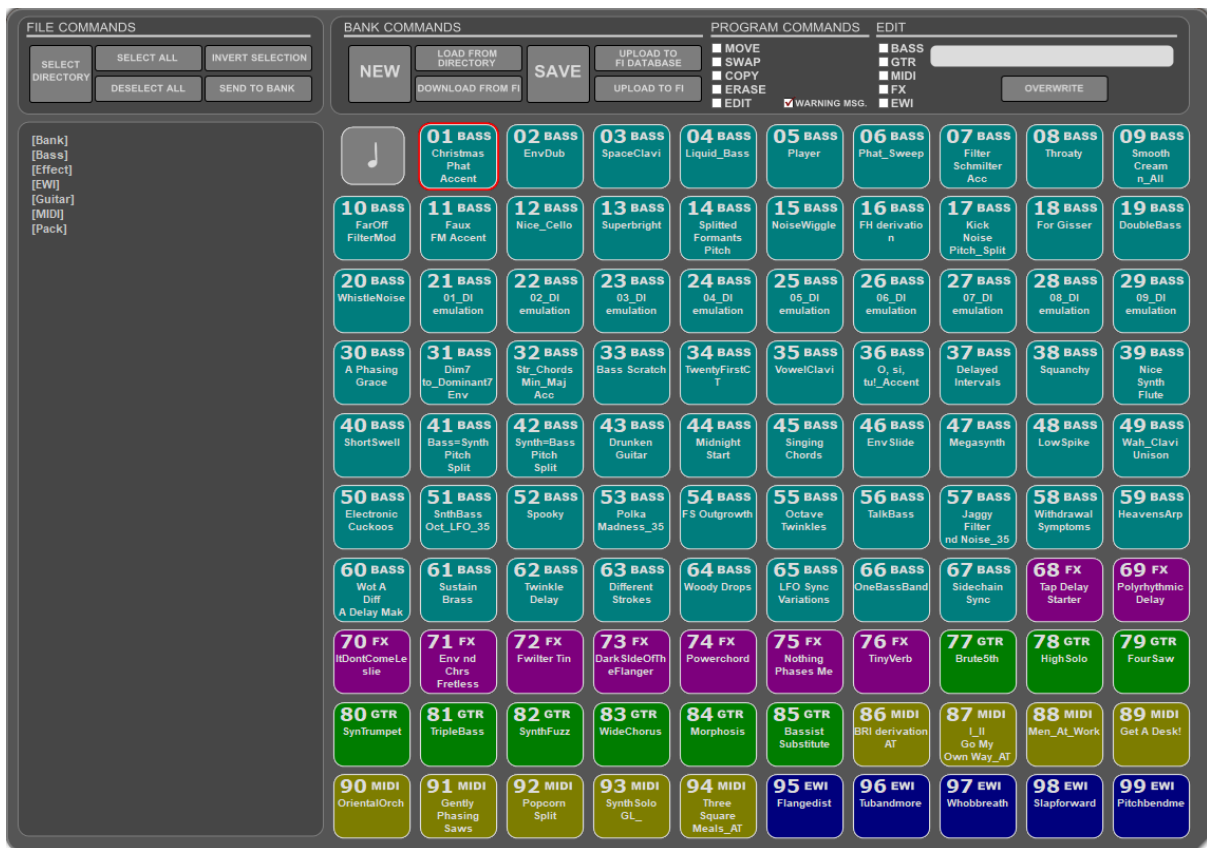

The Manager is a subsection of the Editor Suite devoted entirely to easy program management. Using a drag-and-drop interface, it allows you to display and rearrange the sounds currently stored on your pedal; you can quickly and easily swap locations, add or remove individual patches, rename sounds and change their category, and create copies of sounds. It also allows for a smooth way to browse and audition files stored on your computer (“Local programs”), make changes to them and then add them to your pedal. Not only that, but the Manager is integrated into our [Online Program Database site](#), which allows you to browse, audition and download patches shared by other users (“Global programs”) or upload your own, all directly within the Editor Suite.

The viewing area of the Manager is divided into two main parts. The smaller section on the left contains the Program Pane and its associated [File Command](#) buttons, which are used to browse program files. The larger section on the right is the Tile Window (a graphical representation of the 99 program slots of the FI4) and its associated [Program Command](#) buttons, which are used to load, save, edit and arrange your sounds in order for use on the pedal itself. The tiles themselves show the slot number, (color-coded) category and name.



You can double-click a tile in the Tile Window or a filename in the Program Pane to load its sound into the edit buffer; you can then use the Note Button (shown here) to the left of tile 01 to audition the sound (as long as none of the [Program](#)

[Go to Table of Contents](#)

[Commands](#) checkboxes is ticked) or you can switch to the [Editor](#) view to make changes to the sound's parameters. The Note Button plays MIDI note number 48 (the C one octave below Middle C) at full velocity and uses the same MIDI channel as the [On-Screen Keyboard](#).

Note 1: If a program has been loaded into the Editor via the Manager, the + and - buttons in the Editor's [Program Display](#) will only function for *Local* programs loaded by double-clicking the filename in the Manager's Program Pane. The + and - buttons cannot be used to browse Global program files, nor can they be used to scroll through the tiles of the Tile Window.

Note 2: *Global* programs *cannot* be loaded into the Editor by double-clicking the filename in the Manager's Program Pane; to edit a Global program, you must first drag or send it to the Tile Window and click or double-click the tile.

The functions of the Manager are detailed below.

File Commands



The buttons of this section and the associated Program Pane below it are used to browse and select FI program files on your computer and online for editing and auditioning. Any selected program(s) can simply be dragged from the Program Pane and dropped into the Tile Window, or the dedicated command button can be used. (You can select multiple files by shift-clicking and control-clicking.) The Program Pane can be scrolled using either the mouse scroll wheel or the scroll bar on the right of the pane; finer scrolling can be performed by holding down either SHIFT or CTRL while using the mouse scroll wheel.

From left to right, the buttons' functions are as follows:

- **SELECT DIRECTORY:** Clicking here allows you to open a file location to audition and manage FI program files. The selected location will appear in the Program Pane; the pane can display folders and files. Folder names are shown in square brackets and files are shown using plain text. Double-click a folder name to see its contents. To go back up one level, scroll to the top of the pane and click on the folder icon with the two dots [..].

Upon clicking the **SELECT DIRECTORY** button, you will be presented with two options:

[Go to Table of Contents](#)



- **LOCAL:** Click here to browse FI files stored on your computer;
- **GLOBAL:** Click here to browse FI files hosted on the Future Impact Program Database site directly within the Manager. Upon clicking this button, you will be prompted for your username and password as shown in the image below.

(If you have not yet registered, you will need to visit the [Program Database site](#) and create an account.) Tick the **REMEMBER ME** checkbox if you would like to store your login details for the next time you use the Editor Suite.

Once the program files are visible in the Program Pane you can click on the name to select the file. (You can select multiple files by shift-clicking and control-clicking.) Double-click on the name to load the program into the edit buffer; you can now audition the sound using the Note Button in the Tile Window. For Local files only you can also click the **Editor** button to switch to the [Editor](#) and make changes to the sound. (Global files must be sent to the tiles before they can be edited.)

- **SELECT ALL:** Click to highlight all program files within a single folder.
- **DESELECT ALL:** Click to unhighlight all program files within a single folder.
- **INVERT SELECTION:** Click to change all highlighted files to unhighlighted ones and vice versa.
- **SEND TO BANK:** Click to send all currently-selected program files to the program tiles representing the 99 slots of the pedal. Files can only be sent to *empty* tiles.

A single selected program file will be sent to the currently-selected *empty* tile. If the selected tile is not empty, the file will be sent to the next numerically-higher empty tile. If no tile is selected, the file will be sent to the lowest-numbered *empty* tile.

When multiple program files are selected, they will be sent in the top-to-bottom order they appear in the Program Pane and will fill the *empty* tiles in numerical order, starting from the currently-selected tile. If the currently-selected tile is not empty, the process will begin from the next numerically-higher empty tile and will continue in numerical order, filling only empty tiles. If no tile is selected then the tiles will be filled starting from the lowest-numbered empty tile. Once the highest-numbered empty tile has been filled, no further files will be sent; in other words, the sending process does not wrap around back to a lower-numbered tile than the one selected, even if it is

[Go to Table of Contents](#)

empty, and if the number of selected program files exceeds the number of available empty tiles, then only the first files that fit will be sent.

Note: In the case where you want to send multiple program files and multiple tiles are selected in the Tile Window, the files will be sent starting from the lowest-numbered empty selected tile and will continue filling the empty tiles in numerical order from that point on, regardless of whether they are selected or not. If the lowest-numbered selected tile is not empty, then the tiles will be filled starting from the next numerically-higher empty tile, regardless of whether it is selected or not, and continue filling the next empty tiles in numerical order.

Bank Commands



The buttons of this section control various aspects of the tiles of the Tile Window that correspond to the 99 memory slots of the FI4. The tiles are used to transfer programs between your computer and the FI4, save them to your computer or upload them to the Online Program Database.

From left to right, the buttons' functions are as follows:

- **NEW:** Click to create a new blank template. This will clear all 99 tiles. (It will not delete any files from your computer, nor will it erase any sounds from your FI4.) You can now drag or send program files from the Program Pane into the Tile Window.
- **LOAD FROM DIRECTORY:** Click to load a previously-saved bank of 99 sounds into the Tile Window ready for editing or for sending to the FI4.
- **DOWNLOAD FROM FI:** Click to read the current contents of your FI4 and display them in the Tile Window. (Remember to [write parameter edits into the program](#) first!)
- **SAVE:** Click to save the bank (i.e. the contents of the Tile Window) to your computer. The bank does not need to have all 99 slots filled in order to be saved. After pressing **SAVE**, a dialogue box will open and you can specify a folder into which you would like to save the program files. You can also create a new folder from the dialogue box at the point of saving. To create a new folder, press the **Make New Folder** button, type a name and then press return. Then press **OK** to save the files to the newly-created folder.

Note: It is important to always save to a different folder each time, otherwise there will be duplication of the slot numbers, which will prevent you from correctly loading or writing the program files later.

- **UPLOAD TO FI DATABASE:** Click to begin the upload process. You will first be prompted to save the contents of the Tile Window locally (unless you have already done so). A warning message will then pop up showing you the location of the saved programs. (You can press CTRL+C to copy the entire text of the warning message.) Click **OK** to dismiss the message. The Program Database will now open in a web browser at the “Downloads - Add” window. In that window, click **SELECT FILES** and navigate to the folder location you were shown. Select the program file(s) you wish to add and click **OPEN** to add the file(s) to the window. Add a title, comments and tags as desired then press **ADD** to complete the process.

Note: Newly-uploaded programs won't be visible in the Program Pane until it is refreshed; this happens automatically whenever you navigate into or out of a folder.

- **UPLOAD TO FI:** Click to send the complete contents of the Tile Window to your pedal. If you only want to send a single program or a specific set of programs to the pedal, select only those tiles you wish to send before pressing **UPLOAD TO FI**. (Use shift-click or control-click to select multiple programs in the standard way.) You can still send the contents even if not all 99 tiles are filled. Only the filled tiles will overwrite the slots on your pedal; blank tiles will not make any changes to the contents of your pedal.

Program Commands



The functions of this section are used to manage the tiles' numerical location, name and category. If none of the checkboxes is ticked, then you can simply double-click a tile in order to load that program file into the FI4's edit buffer; you can press the Note Button in order to hear the patch or you can switch to the Editor view to make alterations to the parameters. Ticking any of the Program Command checkboxes hides the Note Button.

By default, you will be shown a warning message if any action is about to erase a tile. If you do not wish to see such messages then untick the **WARNING MSG.** checkbox.

Note: Any changes made to the tiles using the Program Commands will not take effect on the FI4 until you press the UPLOAD TO FI button in the [Bank Commands](#) section.

[Go to Table of Contents](#)

Important: When using the Program Commands to edit a tile's name or category information or to change its numerical location (including when copying), only its program file data will be saved; **any adjustments made using the PARAMETER and EDIT dials will not be saved**, so you must [write these edits into the program file](#) before you press the UPLOAD TO FI button.

From top to bottom, the checkboxes' functions are as follows:

- **MOVE:** After ticking this box, you can click and drag a single tile or multiple tiles to a new location. The moved tile(s) will overwrite the tile(s) in the new location.
- **SWAP:** After ticking this box, you can click and drag a single tile or multiple tiles to a new location and the tiles will change places.
- **COPY:** After ticking this box, you can click and drag a single tile or multiple tiles to a new location and the dragged tile(s) will be copied to the new location, overwriting the tile(s) there.
- **ERASE:** After ticking this box, you can either click a single tile to delete it or you can select multiple tiles and then click any of the selected tiles to delete all the selected tiles.
- **EDIT:** After ticking this box, you can alter the name and category of a tile. You can only change the name of a singly-selected tile; you can change the category of any number of tiles simultaneously.

To change the name of a tile, click the tile to select it. Now click the name shown in the text box in the EDIT section in the upper-right corner of the screen, type the new name then press **OVERWRITE**.

To change the category of any number of tiles, select the tile(s), then from the EDIT section, tick the category checkbox you wish to apply; the choices are **BASS**, **GTR** (guitar), **MIDI**, **FX** (effects) and **EWI** (Electronic Wind Instrument). If you wish to have no category assigned to the tile(s), then untick all the category boxes. Press **OVERWRITE** to assign the new category information.

Note 1: When moving, swapping or copying multiple files, they will always move keeping the physical pattern of their locations (e.g. if you select five tiles in an L-shape, they will move in an L-shape); if you try to move them to the new location and some of the tiles in the pattern stray outside the borders of the tile grid, then only the tiles that are inside the grid will be moved, swapped or copied.

Note 2: Tile number and category name can use up to 8 characters of the filename. Therefore if you send a program whose name is longer than 26 characters to a tile, then the name may get truncated when shown in the Editor's Program Display, when saved, or when written to the FI4.

[Go to Table of Contents](#)

The Editor



The FI4 is a very complex device with over 100 fully-adjustable parameters per sound. These are mostly adjusted in the Editor using sliders but there are a few pushbuttons too. In order to get an overview we recommend you first familiarize yourself with the panel layout in the image above (or in that of the [Alternative Editor Skin](#)) and investigate the [block diagrams](#) of the FI4 algorithms in the Appendix. On the first page of the Appendix, you will find a diagram of the whole device (minus the effects). Note however that the oscillators appear here just as a rough outline; the detailed diagram of the [oscillators](#) is on the second page. The third page shows how the [Effects Block](#) is inserted into the structure of the FI4.

The FI4 has two basic sound sources: The [harmonizer](#)-and-input-instrument block and the [synthesizer](#) block. The synthesizer is driven by the pitch and volume information derived from the sound of the input instrument. The sounds of the FI4 can be created from the synthesizer sound, the harmonizer-and-input-instrument sound, or a mixture of the two.

This all might seem quite daunting or confusing at first but don't worry, the following sections of the manual will explain what all the controls do and teach you what you need to know in order to start editing sounds deeply or building your own.

Let's begin by looking at the more general controls, tools and navigation features before moving on to tackling the parameters themselves.

[Go to Table of Contents](#)

The Program Display



This area in the upper-left corner of the Editor is used to show the currently-loaded sound. The name and category is shown in the long window. The faux-digital window shows the program number (but is blank if the program was loaded via the [Manager's](#) Tile Window).

The four load/save/write commands of the [File Menu](#) are duplicated here as **LOAD**, **SAVE**, **WRITE ONE** and **WRITE ALL** respectively.

Instead of using **LOAD** each time you want to access a new program, you can simply use the - and + buttons (or the left and right arrow keys of your keyboard) to scroll through the programs within your selected directory. You can also use the up and down arrow keys of your keyboard to change banks.

The **INIT** button is used to create a basic initialized program which serves as a useful starting point for a new sound. It is discussed further in the section on [Building Your First Sound](#).)

Note 1: The + and - buttons can only be used to scroll through Local programs (i.e. those stored in folders on your computer); they cannot be used to scroll through the memory slots of your pedal, nor can they be used to scroll through Global programs (i.e. those hosted on our [Online Program Database](#)).

Note 2: The Program Display only shows information for Local programs; it does *not* show a live readout from your pedal. However, if you have populated the Tile Window of the [Manager](#) with the current contents of your pedal using the **DOWNLOAD FROM FI** function and have made no edits to the tiles, then clicking one of the tiles will indirectly allow the slot number and name of that sound on your pedal to be shown in the Program Display.)

On-Screen Keyboard and Mod Wheel



In the lower middle part of the Editor screen there is a keyboard. You can use this to trigger (non-legato) notes on the FI4 in order to test the sound. The keyboard is even “velocity

[Go to Table of Contents](#)

sensitive” as it will produce different key velocity values depending on where you press the key; higher velocities are at the bottom, lower velocities at the top.

To the left of the keyboard is a mod wheel. To adjust it, either left-click and drag it up and down, or use the mouse scroll wheel. Either left-click and drag up and down on the text immediately to its bottom-left, or right-click the wheel itself and use the pop-up menu to set which controller it sends out; the choices are CCs or Aftertouch (AT).

Further to the left is an icon for setting the keyboard’s MIDI channel; either left-click and drag up and down on it, or right-click it and use the pop-up menu. Set this to the same channel as your FI4.

Note: The on-screen keyboard only triggers the *synthesizer* portion of a sound. Therefore any program whose sound is partially (or entirely) constructed from your instrument’s audio signal will not play back as expected when using this keyboard.

Block Reset & Randomize Tool

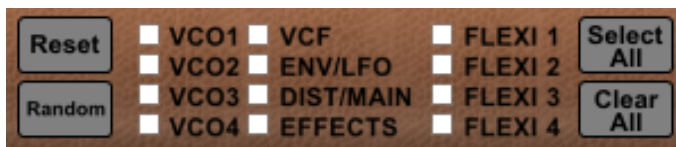

In the lower-right corner of the Editor there is a tool to reset or randomize various [parameter blocks](#). There are twelve checkboxes. These correspond to the four [VCO Blocks](#), the [VCF Block](#), a combination of the [ENVELOPES](#) and [LFO Blocks](#), a combination of the [DISTORTION](#) and [MAIN MIXER Blocks](#), the [EFFECTS Block](#) and the four [FLEXI Controllers](#). Click on a checkbox to select a block. Any number of blocks can be selected and there are buttons to **Select All** or **Clear All** checkboxes.

You can adjust the selected block(s) by clicking on one of the following two buttons:

- **Reset:** Sets the parameters in the block(s) to their lowest values.
- **Random:** Generates random values for all parameters in the block(s).

Note: Though the [MIDI Block](#) does not have its own checkbox, its parameters will be reset whenever a **Reset** is performed with all twelve checkboxes ticked. It does not respond to the **Random** button.

VCO & Flexi Copy Tool



In the lower-left corner of the Editor there is a tool to copy all settings of one [VCO](#) (oscillator) to one or more of the other oscillators or to copy all parameters of one [Flexi Controller](#) to one or more of the other Flexi Controllers.

Click on the **VCO** button to show the VCO checkboxes; click on the **FLEXI** button to show the FLEXI checkboxes. Select a single source from the left side and the destination(s) from the right side, then press **COPY**.

Alternative Editor Skin

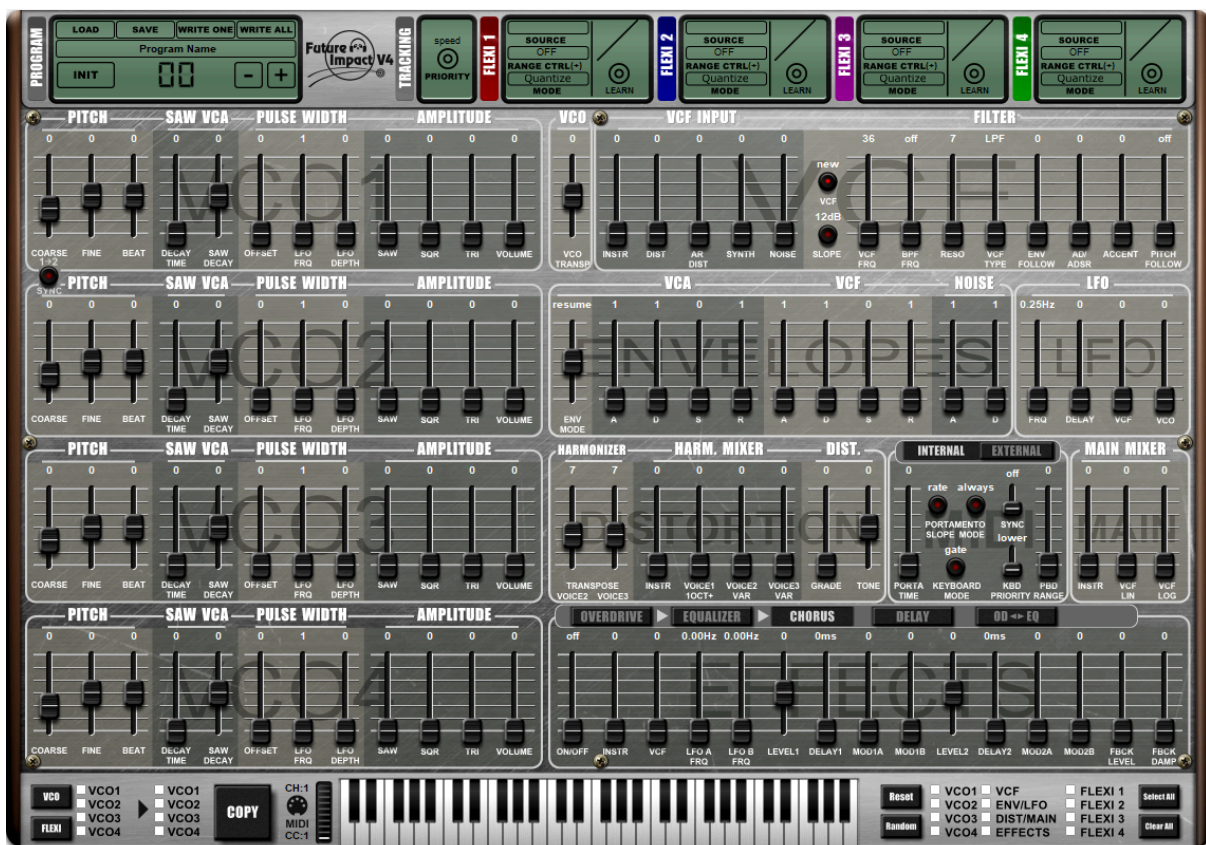

Instead of the classic Future Impact Editor skin, you can use this photorealistic LCD skin. You can select this using the [View Menu](#).

Note: Switching between the classic and LCD skins requires the Editor Suite to be restarted. Save any edits you have made before switching otherwise they will be lost.

[Go to Table of Contents](#)

Editor Parameters

The bulk of the interface of the Editor consists of sliders and pushbuttons which control the various sound-shaping parameters within a program. These are organized into distinct logical groupings called *blocks* and are (with two exceptions) labelled with a “watermark” text indicating the block’s name. Most blocks are subdivided into two or more *sections* and can be identified by the font above the panel. The individual sections of a block also have differently-colored panels.

The various blocks are discussed below. The sliders and pushbuttons within each block are described (mostly) individually and their ranges or settings are given in parentheses after their names.

Note: Double-clicking a slider will reset it to its default value. Pressing CTRL+Z or CTRL+Y will respectively undo or redo any edits made to parameters.

Pitch Tracking



This controls how the FI4 responds to pitch information received from your instrument via the audio input:

- **PRIORITY *PUSHBUTTON* (SPEED/ACCURACY):**
Selects whether the FI4’s pitch tracking prioritizes speed or pitch accuracy.

When set to **SPEED**, a note is outputted as soon as a trigger is detected; this is at the pitch of the previously-played note until the pedal has determined the pitch of the new note, whereupon it jumps to that new pitch. This works well for notes which are close together in pitch but it can cause a “pitch blip” if making big leaps.

When set to **ACCURACY**, a note is only outputted once its pitch has been determined. This slightly increases latency but eliminates the “pitch blip”. This is especially useful when playing octave leaps, or when using pitch as a Flexi source or range control.

VCO Block

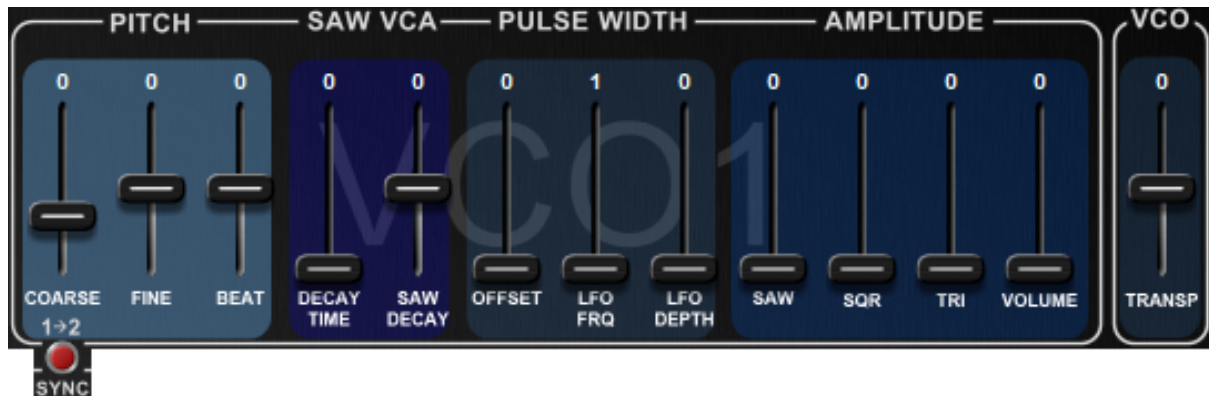

The FI4 contains four identical Voltage-Controlled Oscillators (VCOs) and these provide the basic sound source for the synthesizer. Each oscillator has three waveforms (saw, square and triangle) which can be used simultaneously. The sliders in this block adjust the tuning, volume and character of the oscillator. The oscillator blocks are located on the left-hand side of the Editor screen and, moving from left to right, their sliders are as follows:

- **PITCH COARSE (-24...48):**
Determines the pitch of the oscillator in semitones. A setting of 0 will generate the same pitch as the input signal.
- **PITCH FINE (-63...63):**
Detunes the oscillator by fractions of a semitone. You can use this option to correct the imperfect harmonies of the well-tempered scale.
- **PITCH BEAT (-63...63):**
This is also a detuning control, but instead of detuning by a fraction of a semitone, it detunes by a fixed number of Hz.

To illustrate this function let's use the example of two oscillators pitched in unison, but slightly detuned in order to create a beating between them. The speed of this beating is known as the "beat frequency". If you were to play a middle C and adjust the FINE slider to achieve a beat frequency of 2Hz, then playing the C an octave above would double the beat frequency to 4Hz; likewise, playing C an octave below would halve the beat frequency to 1Hz. If you instead detune using the BEAT slider, then the beat frequency will remain constant, irrespective of the pitch being played.

- **SAW VCA DECAY TIME (0...127):**
The amplitude of the saw waveform can be given its own individual decay envelope which will be triggered each time a new note is played. The decay time is set here; it determines the time it takes the volume of the saw waveform to change from the level set by SAW DECAY to the level set by AMPLITUDE SAW. The volume can increase or decrease depending on whether SAW DECAY is given a positive or a

negative value. See below for further details.

- **SAW VCA SAW DECAY (-63...63):**

This parameter determines the initial amplitude of the decaying portion of the saw waveform and whether the volume increases or decreases from that point on.

A setting of 63 causes the decay envelope to begin from the saw waveform's *maximum amplitude* (i.e. the same volume you get by setting 127 in AMPLITUDE SAW). The amplitude will thus *fall* to the level set by AMPLITUDE SAW (unless the latter is set to 127, in which case there will be no change in volume).

A setting of -63 causes the decay envelope to begin from the saw waveform's *minimum amplitude* (silence) and thus the amplitude will *rise* to the level set by AMPLITUDE SAW. (Obviously if the latter is set to 0, you won't hear anything at all.)

Any SAW DECAY setting *between* -63 and 63 will produce an initial amplitude which varies according to the value set by AMPLITUDE SAW. The various combinations of settings of these two sliders allow a wide range of possibilities.

- **PULSE WIDTH OFFSET¹⁴ (0...127):**

The pulse width of the square waveform can be adjusted between symmetrical (50% duty cycle) when set at 0 and narrow pulse (10% duty cycle) when set at 127. (See the diagram in the [Pulse Width Settings](#) section for details.)

- **PULSE WIDTH LFO FRQ¹⁵ (1...127)¹⁶:**

Each oscillator has its own dedicated LFO (low frequency oscillator) for modulating the pulse width of the square wave. Here you can adjust the LFO frequency. (See the [LFO Frequency Lookup Table](#) in the Appendix for details of the actual frequencies).

- **PULSE WIDTH LFO DEPTH (0...127):**

This controls the amount of modulation from the aforementioned dedicated LFO. You will need to make sure that the chosen combination of OFFSET and LFO DEPTH settings does not stray beyond the usable range of modulation.

- **AMPLITUDE SAW (0...127):**

Adjusts the volume of the sawtooth wave. This is a harmonically rich waveform, containing all the overtones of the harmonic series; the higher the frequency of the overtone, the lower its amplitude is. This gives a bright and buzzy sound.

¹⁴ In the case of VCO3 and VCO4, this slider has some shared functionality as it also controls the pulse width of LFO3 and LFO4 which are two of the [Special Flexi-only Modulation Sources](#). See that section for further details.

¹⁵ In the case of VCO3 and VCO4, this slider has some shared functionality as it also controls parameters of the [Special Flexi-only Modulation Sources](#): LFO3, LFO4, White Noise and Pink Noise. This sharing means that there are LFOs with different scaling simultaneously assigned to the same slider, hence a readout in Hz cannot be displayed here.

¹⁶ When MIDI Sync is set to "LFO4", the values of this slider (for VCO4 only) change from 0-127 to note lengths. See the sections on [MIDI Clock Sync of LFO4](#) and [MIDI Sync](#), for further details.

- **AMPLITUDE SQR (0...127):**
Adjusts the volume of the square wave. This waveform contains only the odd-numbered overtones of the harmonic series. This gives a hollow sound.
- **AMPLITUDE TRI (0...127):**
Adjusts the volume of the triangle wave. This waveform also contains only the odd-numbered overtones of the harmonic series but, as their frequencies increase, their volumes taper off much more steeply than those in the square wave. This gives a deep sound with a strong fundamental.
- **AMPLITUDE VOLUME (0...127):**
This is the master volume of the oscillator. Along with the individual waveform amplitude sliders, this has an especially important role in the generation of foldover distortion (see below).
- **1→2 SYNC PUSHBUTTON (ON/OFF):**
Located between the VCO1 and VCO2 panels in line with the PITCH COARSE sliders is the control for **OSCILLATOR SYNC**. When enabled, this feature forces VCO2's phase to be reset each time VCO1's waveform starts a new phase cycle.

If the two VCOs are tuned to the same frequency, then there's little difference to hear. However, if VCO2 is tuned higher than VCO1, then some interesting waveforms are created when VCO2 is interrupted partway through a cycle (as shown in the diagram below). Further interesting sounds can be created by sweeping the pitch of VCO2 with an envelope or LFO via a [Flexi Controller](#) while it is synchronized to VCO1.

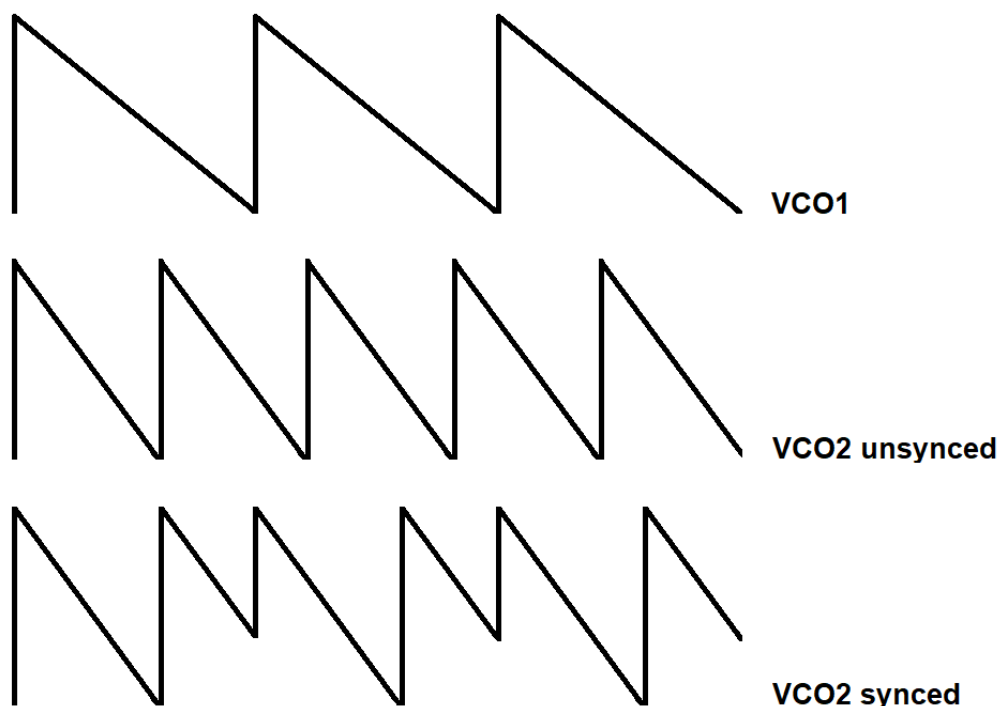

This function makes more sense musically if VCO1 is set to a lower pitch than that of VCO2.

Note: VCO1 frequency must be kept below 1 kHz for oscillator sync to function correctly.

- **VCO TRANSPOSITION (-24...0...24):**
Located immediately to the right of VCO1 in the Editor. This transposes all four oscillators together in semitone steps.

Remember: You can make use of the [VCO Copy Tool](#) to copy the settings of one VCO to any other(s).

Foldover Distortion

This is a special feature of the FI4. Depending on the implemented algorithm, when a signal processor is overloaded it will either clip the peak of the signal or it will fold over. While clipping is often used to generate a moderate amount of overtones, foldover generates a very high overtone content. The FI4's huge processing power allows it to handle this high overtone content with minimal aliasing artefacts.

Foldover Distortion can happen in the FI4 either within a single oscillator or within a combination of multiple oscillators.

No individual waveform (saw, square or triangle) within an oscillator can cause Foldover Distortion *by itself*, even at its maximum amplitude. However, Foldover Distortion *can* occur within an oscillator if the sum of all three of its waveforms' amplitudes exceeds 127; whether or not it *does* occur depends on the phase of the components.

Foldover distortion can also happen between separate oscillators when the sum of the amplitudes (i.e. VOLUME sliders) of all four of the FI4's oscillators exceeds 127. The effect of foldover distortion between oscillators that are tuned to different frequencies (either coarsely or finely) is rather unpredictable so leaves a lot of room for experimentation.

Since all four oscillators can be made to have dynamically changing portions, either by using their PULSE WIDTH and SAW VCA sliders or by assigning a [Flexi Controller](#) to any of their AMPLITUDE or VOLUME sliders, you can use them to create sounds with dynamically changing spectra, without even using a filter.

Distortion Block



The Distortion Block applies distortion to the original instrument signal and to the three transposed voices generated by the Harmonizer.¹⁷ VOICE1 is fixed at 1 octave above the input signal, whereas the transpositions of VOICE2 and VOICE3 are variable.

¹⁷ The Distortion Block does not apply distortion to the *synth* signal. The distorted sound does however get routed through the filter so can be shaped to create synth-like sounds.

The Distortion Block is also the source of the **Attack/Release Distortion**. See the detailed explanation of [Attack/Release Distortion](#) in the **VCF INPUT** section of the **VCF Block**.

Moving from left to right, the sliders of the Distortion Block are as follows:

- **HARMONIZER TRANSPOSE VOICE2/VOICE3 (-12, -5, 7, 12, 19, 24):**
Sets the transposition in semitones of the two variable voices. Identical settings of the two voices are scaled such that they are not exactly equal and will have a slight beating between them.
- **HARM MIXER INSTR/VOICE1/VOICE2/VOICE3 (0...127):**
Sets the volume levels of the input instrument signal and the three transposed voices of the Harmonizer being sent to the distortion.
- **DISTORTION GRADE (0...31):**
Adjusts the degree of distortion. Even at 0, some distortion is still present.
- **DISTORTION TONE (0...127):**
Sets the tone of the distortion. The filter is an equalizer set to 2100 Hz and Q=0.8. The slider cuts or boosts by up to 11dB at this frequency. A setting of 64 is flat (0dB).

Note: Whenever MIDI is being used to trigger the FI4, the Distortion Block has no function. (MIDI [Sustain](#) is not triggering; it is sustaining a note which has already been triggered, so in Bass, Guitar or Split [Instrument Mode](#), you can still use the Distortion Block as normal.)

Envelopes Block

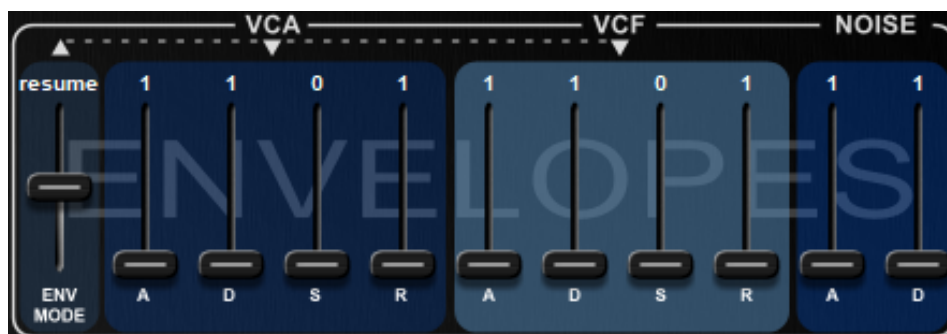

Envelopes are configurable control signals which are used to adjust parameters over time. The two most common uses of envelopes in synthesizers are to adjust the loudness of the oscillators and to adjust the filter cutoff frequency. An envelope is made up of distinct portions called “stages”. The most widely used four stages are ATTACK, DECAY, SUSTAIN and RELEASE (ADSR). (The FI4’s envelopes have either two or four of these stages, depending on the mode selected.) The A, D and R stages are time-based parameters whereas the S stage is a level (or amount) parameter. The stages are described below:

[Go to Table of Contents](#)

- ATTACK sets the time the envelope takes to rise from zero to maximum after a note is played.
- DECAY sets the time the envelope takes to decay from maximum back down to the level set by the SUSTAIN.
- SUSTAIN sets the level the envelope maintains after the decay stage has finished.
- RELEASE sets the time the envelope takes to decay from its current level back down to zero when a note is released.

The FI4 has three dedicated envelopes which control the Voltage-Controlled Amplifier (VCA), the Voltage-Controlled Filter (VCF) and the Noise Generator respectively. The VCA and VCF envelope generators have three different modes (VINTAGE, ADSR in RESTART and ADSR in RESET-TO-ZERO) which are selected using the Envelope Mode slider.

Moving from left to right, the sliders of the Envelopes Block are as follows:

- **ENV MODE (VINTAGE/RESUME/RESET):**
Sets the behavior of both the VCA and VCF envelopes as described below.
- **VCA A/(D)/(S*)/R (1...127):**
Changes the volume of the synth signal coming from the VCOs dynamically over time.
- **VCF A/D/(S*)/(R) (1...127):**
Changes the cutoff frequency of the filter dynamically over time.
- **NOISE A/D (1...127):**
Changes the volume of the noise source dynamically over time.

* The sustain stages of the two ADSR envelopes actually start their range from 0.

Note: The VCF and NOISE envelopes can be freely assigned to many other parameters when used as a control source with a Flexi Controller. (See the section on [Flexi Controllers](#) below for a detailed explanation.)

Envelope Mode Behavior

There are 3 different envelope behavior modes: **VINTAGE**, **RESUME** and **RESET**.

In **VINTAGE** mode the envelopes are the same as those found in pre-v3 versions of the FI firmware. (Here the D and S sliders of the VCA envelope and the S and R sliders of the VCF envelopes are greyed out and cannot be used.) In this mode, all three envelopes have a *linear* ramp and are triggered each time you play a note. They differ as follows:

The **VCA** envelope is **Attack-Release (AR)**. This means that when you play a note, the VCA envelope's attack stage will start from zero and rise to maximum. It will maintain this level until you release the note, whereupon it will enter the release stage and fade out with a release time.

The **VCF** envelope and the **NOISE** envelope are both **Attack-Decay (AD)**. This means that when you play a note, they will start from zero and rise to maximum, whereupon they immediately begin to decay to zero.

Note: While the synthesizer sound is gated with the VCA envelope, the noise source is not; therefore, if you play short notes and the DECAY stage of the NOISE envelope is set long, the noise can be sustained longer than the synthesizer note itself. (This is true in all three envelope modes.)

In **RESUME** and **RESET** modes, *all* sliders of the VCA envelope and of the VCF envelope become active giving *full ADSR* envelopes, practically identical to those found in a classic 1970s 3-oscillator monosynth. They can be adjusted in a range of 1 millisecond to 10 seconds. Unlike the AD and AR envelopes of Vintage mode, the two ADSR envelopes have an *exponential* ramp and their adjustment range is extended strongly in both directions.

The **RESUME** and **RESET** modes differ only in how they behave when a new trigger event occurs before the envelope generator has completed its previous envelope sequence:

In **RESUME** mode the envelope will begin a new attack stage from *whatever level* it was at immediately before the note was played;

In **RESET** (or **RESET-TO-ZERO**) mode the envelope will always start the new attack stage from zero. So every note will have an identical attack.

Note: In pre-V4 versions of the FI, the release stages of the ADSR generators were only fully exploitable when the FI was played via MIDI. When played via the audio input, the actual release time used was either the audio signal's own release or the ADSR's release setting, whichever was shorter. In V4, however, the programmed release time is always used, therefore some of your older sounds may now play back slightly differently than expected and you may need to adjust their release times accordingly.

VCF Block



The Voltage-Controlled Filter (VCF) is one of the most important sound-shaping tools in a synthesizer. Basically it removes certain frequencies from a sound, thus altering its harmonic content. Depending on the type of filter used, the frequencies *above*, *below* or *at* a specified “cutoff” frequency are removed. This cutoff frequency can be modulated dynamically from different sources (e.g. an envelope), thus creating sounds which evolve over time.

The FI4 has two filters which are connected in parallel. The first can be switched between Lowpass, Highpass, Bandpass and Notch types. The second is Bandpass-only and its cutoff can be offset from that of the first. The filters have both 12dB and 24dB per octave slopes and two scaling modes.

The VCF Block is split into two sections in the Editor:

1. **VCF INPUT** - A five-channel audio mixer which feeds into the filter.
2. **FILTER** - As described above.

VCF INPUT

Moving from left to right, the sliders in this section are as follows:

- **VCF INPUT INSTR (0...127):**
Sets the volume of the direct audio signal of your instrument. Unity gain is at 127.
- **VCF INPUT DIST (0...127):**
Sets the volume of the signal coming from the [Distortion Block](#).
- **VCF INPUT AR DIST (0...127):**
Sets the volume of the signal coming from the Distortion Block but processed in a special way. (See **Attack/Release Distortion** below for details.)
- **VCF INPUT SYNTH (0...127):**
Sets the volume of the audio signal coming from the [VCO Block](#) (the synthesizer).
- **VCF INPUT NOISE (0...127):**
Sets the volume of the audio signal coming from the Noise Generator.

[Go to Table of Contents](#)

Attack/Release Distortion

As mentioned earlier, the synthesizer signal passes through the VCA and its loudness contour is controlled by the VCA envelope. If you set a long attack time on the VCA envelope, then the synth sound will fade in slowly after a note is played. By contrast, the loudness contour of the distortion signal is ordinarily only controlled by the volume envelope of your instrument. Like the DIST slider, the AR DIST slider also controls the volume of the sound coming from the [Distortion Block](#). The key difference is that the signal sent to the AR DIST slider gets first further processed through its own separate VCA; this separate VCA is controlled by the *inverted version* of the (synthesizer) VCA envelope set in the [Envelopes Block](#).

The practical use of this feature comes when using AR DIST and SYNTH together and can be illustrated by the following example. Set the AR DIST and SYNTH sliders so that the volumes of their audio signals are roughly the same and set a relatively long attack time on the VCA envelope. Now when you play a note, you will initially only hear sound from the Distortion Block but this then crossfades into sound from the [VCO Block](#) (Synthesizer). Although relatively few of the factory sounds use this feature, this can be used to perfectly mask any potential tracking errors or latency of the synthesizer sound.

Beware that even when in the (exponential) [ADSR envelope modes](#), the AR DIST is still controlled by a *linear* AR envelope. This means that the crossfading will not happen as smoothly as it does in Vintage mode.

Note: When the FI4 is played solely via its MIDI IN port, adjusting the INSTR, DIST and AR DIST sliders will have no effect. This is because they control audio signals derived from the input signal of your instrument connected at the INPUT socket.

FILTER

The rightmost four sliders in the filter section adjust the depth of control signals which modulate the filter's cutoff frequency. The remaining sliders and buttons adjust the filter's character and behavior.

Moving from left to right, the sliders (or pushbutton switches, where indicated) in this section are as follows:

- **VCF FILTER MODE *PUSHBUTTON* (VINTAGE/NEW):**
Toggles between the two scaling modes of the VCF FRQ slider (see below for details). The slider resets to minimum whenever you toggle between the two modes.

VINTAGE mode faithfully reproduces the unique qualities of the Deep Impact's somewhat "imperfect" filter. This mode is necessary for the 9 Deep Impact emulation sounds (programs 21-29 of the factory soundset).

For everything else we recommend using NEW mode which is the Future Impact's far superior filter implementation.

- **VCF FILTER SLOPE *PUSHBUTTON* (12 dB / 24 dB):**
Toggles the filter mode between 12 dB/octave and 24 dB/octave. This adjusts how drastically the frequencies around the filter's cutoff point are attenuated. 24 dB is the more drastic.
- **VCF FRQ (0...80 (VINTAGE), 36...122 (NEW)):**
Adjusts the cutoff frequency of the filter. Depending on the filter type selected (see VCF TYPE below), the frequencies above, below or at this point will be attenuated.

In VINTAGE mode the scaling is roughly 10 units per octave.

In NEW mode, the scaling is in semitones and the slider's value actually displays MIDI note numbers. The filter's cutoff frequency is therefore that of whichever MIDI note is currently shown. (MIDI note 36 is 65.41 Hz; MIDI note 122 is 9397.27 Hz. See the [VCF Frequency Lookup Table](#) in the Appendix for full details.)

The cutoff of the filter can be further controlled using either MIDI CC11 or CC74. (See the [MIDI Implementation](#) section for details.) It can also be made to deviate ± 1 , ± 2 or ± 4 octaves from the cutoff value set by the VCF FRQ slider in the program. The range is set by **VCF CONTROL RANGE** in the [Global Menu](#).

- **BPF FRQ (OFF, 1...24):**
Sets the cutoff frequency of the parallel second (bandpass-only) filter; measured as an offset in semitones from the cutoff frequency of the first filter. OFF bypasses the second filter.

Both filters share the RESO and SLOPE parameters. Any control signal modulating the first filter's cutoff frequency will cause the second filter's frequency to move in step with it. However, if a [Flexi Controller](#) is assigned to BPF FRQ but not also to VCF FRQ, then the two filters might not always move exactly in step any more.

Offsetting the cutoff frequencies of the two filters generates dual resonant peaks and provides an excellent way to create sounds with vowel-like formants resembling the human voice.

- **RESO (7...127):**
Adjusts the resonance peak (or "Q") of the filter on a scale of $Q=0.7...12.7$. Higher values boost the frequencies at the filter's cutoff point creating a characteristic peak.
- **VCF TYPE (LPF, HPF, BPF, NTC, OFF):**
Selects between Lowpass, Highpass, Bandpass and Notch filter types. Setting the slider to OFF will only bypass *this* filter; the second (Bandpass-only) filter will remain

active unless the BPF FRQ slider is also set to OFF.

The four filter types are as follows:

1. Lowpass - Attenuates the frequencies *above* the cutoff;
2. Highpass - Attenuates the frequencies *below* the cutoff;
3. Bandpass - Attenuates the frequencies *on either side of* the cutoff;
4. Notch - Attenuates the frequencies *at* the cutoff.

- **ENV FOLLOW (0...127):**

Adjusts the extent to which the filter's cutoff is modulated by the Envelope Follower. The envelope follower signal corresponds exactly to the volume envelope of the input instrument. (This parameter has no function if the FI4 is being played solely via MIDI.)

- **AD/ADSR (0...127):**

Adjusts the extent to which the filter's cutoff is modulated by the fully-adjustable VCF AD/ADSR Envelope set in the [Envelopes Block](#).

- **ACCENT (0...127):**

Adjusts the extent to which the filter's cutoff is modulated by the maximum volume level of a note played on the input instrument.¹⁸

Like the Envelope Follower, Accent is a dynamics parameter. Whereas the Envelope Follower outputs a continuously-changing signal which exactly follows the amplitude curve of the note played on the input instrument, Accent outputs a steady signal determined by the note's maximum loudness value.

When the FI4 is in SYNTH or EWI Instrument Mode, Accent adjusts the extent to which the filter's cutoff is modulated by keyboard velocity.¹⁹

- **PITCH FOLLOW (ON/OFF):**

If switched to ON then the filter cutoff will be modulated by the pitch of the note being played. The filter cutoff will track the input pitch 1:1. That is, playing a note one octave higher will double the cutoff frequency; playing one octave lower will halve the cutoff frequency.

This can be used for many purposes. One example is to generate tuned whistling sounds by setting filter resonance high.

¹⁸ In pre-V4 versions of the FI, Accent equated to the *initial* volume of the note whereas now it equates to the *maximum* volume of *any part* of the note. Therefore some of your older-format sounds may now play with a slightly higher accent value than expected and may need to be adjusted accordingly.

¹⁹ In pre-v3 versions of the FI it was the Envelope Follower which adjusted the extent to which the filter's cutoff was modulated by keyboard velocity. So if a .prg-format program is ported to the .pr4 format and is intended to be triggered via MIDI, then the Envelope Follower parameter value must be copied to the Accent parameter in order for the program to play as expected.

LFO Block



The FI4 has a dedicated Low Frequency Oscillator (LFO) for modulating the cutoff frequency of the VCF and the pitch of the VCOs. This can be used to create pitch vibrato and filter “wobbles”.

Moving from left to right, the sliders of the LFO Block are as follows:

- **LFO FRQ (0.25Hz...28.02Hz):**
Sets the frequency of the LFO.
- **LFO DELAY (0...127):**
Each time a new note is played an envelope is started that fades in the LFO amplitude with a variable delay. If set to zero then the set LFO amplitude is reached immediately.
- **LFO VCF / VCO (0...127):**
Sets the LFO depth individually for both destinations.

If desired, the modulation depths of both LFO VCF and VCO can be controlled together by MIDI CC1. The depth set in the program by the two sliders will be reached if CC1 is at maximum (127). (See the [MIDI Implementation](#) section for more details.)

Note 1: The LFO can be freely assigned to many other parameters when used as a control source with a Flexi Controller. (See the section on [Flexi Controllers](#) for a detailed explanation.)

Note 2: The global LFO *cannot* be synchronized to an incoming MIDI clock signal.

MIDI Block

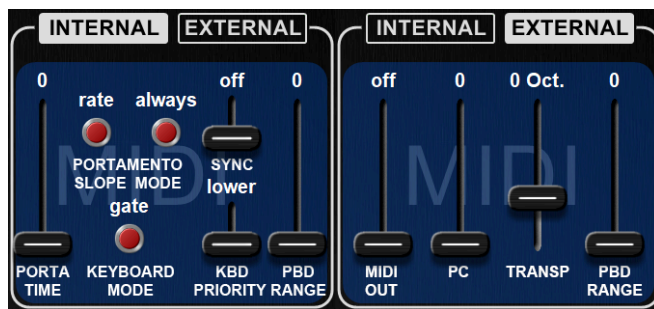

From v4.11 onwards the MIDI Block contains two tabs, one for Internal MIDI, the other for External MIDI.

INTERNAL controls the parameters of the FI4's internal synthesizer engine used when it is responding to incoming MIDI note messages or MIDI clock.

EXTERNAL controls the parameters needed for using the FI4 to play an external synthesizer via the [MIDI Triggering](#) feature.

Internal MIDI Tab

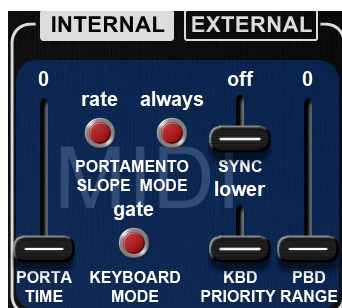

The parameters in this tab are relevant only if the FI4 is being played using its MIDI IN port or if it is being synchronized to a MIDI clock signal via the MIDI IN port.

Moving (roughly) from left to right, the sliders (or pushbutton switches, where indicated) in this tab are as follows:

- **PORTA TIME (0...127):**
Sets the portamento time. If this is set to a non-zero value, the pitch will glide from one note to the other with an adjustable time.

Portamento time and portamento on/off state can be controlled via MIDI using CC5 and CC65 respectively. See the [MIDI Implementation](#) section for further details.

- **PORTAMENTO SLOPE *PUSHBUTTON* (TIME, RATE):**
When set to TIME, the portamento *time* between any two notes will always be the same, no matter how far apart they are. When set to RATE, the portamento *rate* will always be the same, so the greater the distance between the two notes, the longer portamento time will be.
- **PORTAMENTO MODE *PUSHBUTTON* (ALWAYS, LEGATO):**
This switch determines whether portamento will happen on every new note or only on notes that are played legato.
- **KEYBOARD MODE *PUSHBUTTON* (TRIG, GATE):**
In GATE MODE a new attack stage of the envelopes will only occur if you release all keys before pressing another. In TRIGGER MODE a new attack stage will occur upon every keypress.
- **SYNC (OFF, LFO4, DELAY1, DELAY1+2):** This switch chooses which parameter(s) will synchronize to an incoming MIDI clock signal. Note that here, DELAY1 and DELAY2 refer to the two sliders of the *Delay effect only*; the 2 delay sliders of the Chorus effect cannot be synchronized to a MIDI clock signal. LFO4 is a [special modulation source](#) that can only be used via a [Flexi Controller](#).

Whenever SYNC is enabled for the DELAY1, DELAY2 or LFO4, the values of their sliders change to note lengths. See the dedicated sections on [Delay](#) and [MIDI Clock Sync of LFO4](#) for details.

The range of MIDI Sync is 30-480 BPM. If the incoming clock signal is outside that range then it will be limited to the border value closest to it. (A program that uses MIDI Sync defaults to 120 BPM if no MIDI clock signal is detected at the point it is loaded.)

- **KBD PRIORITY (LOWER, UPPER, FIRST, LAST):**
Keyboard priority. This parameter determines what happens if you play more than one note at a time. LOWER: Whichever note is lowest will be played. UPPER: Whichever note is highest will be played. FIRST: Whichever note was pressed first will be played. LAST: Whichever note was pressed last will be played.
- **PBD RANGE (0...24):**
Sets the pitch bend range (both up and down) in semitones when the pitch bend wheel is used.

Note: This parameter is mirrored between the Internal and External tabs, therefore adjusting the slider in one tab will automatically adjust the slider in the other tab.

External MIDI Tab

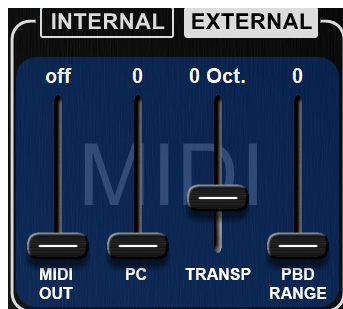

The parameters in this tab are relevant only if the FI4 is being used to convert audio signals from the input into MIDI note data in order to trigger an external MIDI synthesizer. (Please see the section on [MIDI Triggering](#) for more details.)

Moving from left to right, the sliders in this tab are as follows:

- **MIDI Out (ON/OFF):**
Selects whether or not the current FI4 program generates and sends MIDI messages to an external synthesizer; it also determines which Program Change messages are sent out when the FI4 program is loaded. These MIDI messages are always sent using the FI4's own MIDI channel as set in the **Global Menu**.

When set to OFF, no MIDI note messages are generated; the FI4 will send out the PC number of its own selected program (provided MIDI Thru is enabled).

When set to ON, audio signals are converted to MIDI note messages and these are sent out from the FI4's MIDI Out port. the FI4 will send out the PC number as set in the following parameter.

- **PC (0...127):**
Sets the Program Change message that is sent to the external synthesizer when the current FI4 program is loaded (and the above MIDI Out parameter is set to ON).
- **TRANSP (-1 Oct., 0 Oct., +1 Oct., +2 Oct.):**
Sets an optional transposition offset of 1 octave down, 1 octave up or 2 octaves up on the external synthesizer. This ensures that you can play the desired range of the external synthesizer using the desired range of your input instrument.
- **PBD RANGE (0...24):**
Sets the pitch bend range (both up and down) in semitones which is used to perform real-time pitch correction when converting audio into MIDI note data. This parameter must be set to the same value as the pitch bend setting on your external synthesizer.

Note: This parameter is mirrored between the Internal and External tabs, therefore adjusting the slider in one tab will automatically adjust the slider in the other tab.

[Go to Table of Contents](#)

Main Mixer Block



This is a simple two-channel audio mixer situated before the final output to the effect section.

Moving from left to right, the sliders in this block are as follows:

- **INSTR (0...127):**
Sets the volume of the clean input instrument signal. Unity gain is at 127.
- **VCF LIN (0...127):**
Sets the volume of the signal coming from the output of the entire [VCF Block](#) using a linear scale. (This signal comprises all five sliders of the [VCF INPUT](#) section, routed through the filter section).
- **VCF LOG (0...127):**
Adjusts the same signal as the VCF LIN slider but instead uses a logarithmic scale. This gives a more natural sweep of the input values and so offers a useful alternative for controlling the VCF volume path when working with [Flexi Controllers](#).

Note: In order to hear the sound coming from the VCF, both the VCF LIN and the VCF LOG sliders must be set to non-zero values.

The INSTR and VCF signals can be further controlled via MIDI using CC92 and CC2 respectively. Each of these MIDI volume controls is logarithmic and is in series at the end of its respective signal path. (See the [MIDI Implementation](#) section for more details.)

Effects Block

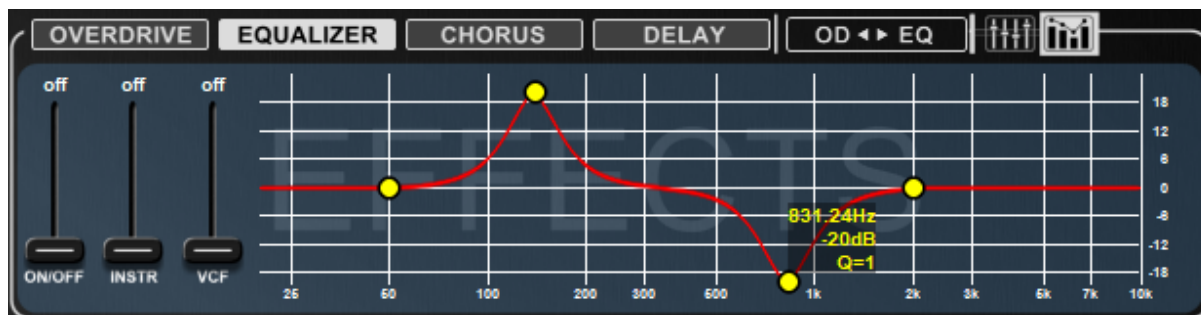

This block contains four effects: [Overdrive](#), [Equalizer \(EQ\)](#), [Chorus](#) and [Delay](#). Up to three of the effects can be used simultaneously, though **Chorus and Delay cannot be used together**. Chorus or Delay is fixed at the end of the chain but the order of the other two can be changed at will. The effects are fed by the INSTR and VCF outputs from the Main Mixer.

The panel for only *one* of the four effects can be displayed at any one time. Click on one of the four tabs (**OVERDRIVE**, **EQUALIZER**, **CHORUS**, **DELAY**) above the panel to display that effect's panel - that tab will now become light gray to indicate it can be edited.

There are three sliders common to the effects. Moving from left to right they are as follows:

- **ON/OFF (ON/OFF):**
Activates or bypasses the effect. When activated, the effect's tab will be illuminated with a red border.
- **INSTR (ON/OFF (EQ and Overdrive), 0...127 (Chorus and Delay)):**
A blend control regulating how much of the dry input instrument signal from the Main Mixer gets sent to the effect. In EQ and Overdrive it can only be either 0% or 100% whereas in Chorus and Delay there is a continuous blend.
- **VCF (ON/OFF (EQ and Overdrive), 0...127 (Chorus and Delay)):**
A blend control regulating how much of the VCF signal from the Main Mixer gets sent to the effect. In EQ and Overdrive it can only be either 0% or 100% whereas in Chorus and Delay there is a continuous blend.

Effects Chain Order

The four effects run in series from left to right.

To the right of the Delay tab there is another tab: 

Clicking on this swaps the order of the EQ and Overdrive effects.

If any of the effects is turned off then its tab's border will become dim. Being able to quickly disable a single effect in this way means you can roughly adjust each effect individually, turn on the required combination to check the sound and then make any fine adjustments.

The four effects will be explained in turn below.

Effect 1: Overdrive



At lower levels, you can use this effect to create sounds that emulate the warmth and breakup of a tube amplifier. At higher levels you can create some quite grinding distortion sounds.

Moving from left to right, the sliders unique to this effect are as follows:

- **DRIVE (0...127):**
Sets the amount of distortion. Even when set to 0, the input signal is still subtly overdriven.
- **LEVEL (-6...+6):**
Adjusts the output level in 1dB steps. Adjusting DRIVE will change the level of the signal in a somewhat unpredictable manner, therefore an output level adjustment is necessary here.

Effect 2: Equalizer

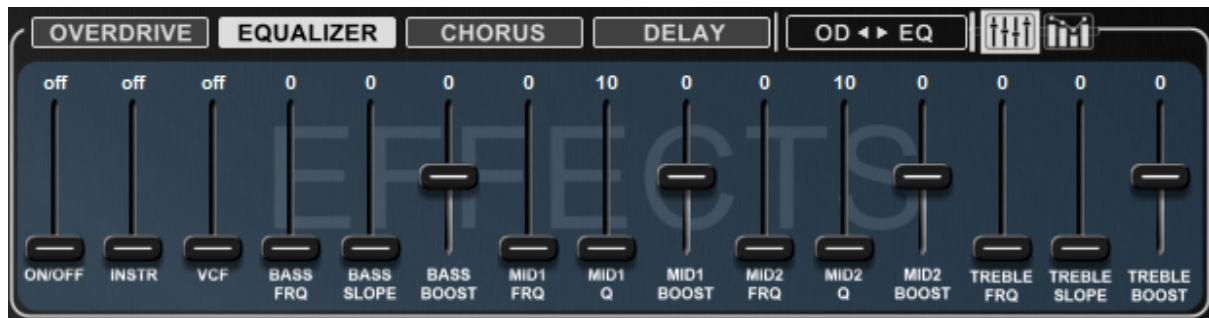

The Equalizer consists of a bass shelf tone control, two parametric band equalizer stages, and a treble shelf tone control.

Moving from left to right, the sliders unique to this effect are as follows:

- **BASS FRQ (0...127):**
Adjusts the frequency of the bass shelf filter in the range of 50...270 Hz.
- **BASS SLOPE (0...127):**
Adjusts the steepness of the bass filter in a range of 3...10dB/octave.
- **BASS BOOST (-20...+20):**
Boosts or cuts the bass by up to 20dB.
- **MID1 FRQ, MID2 FRQ (0...127):**
Adjusts the center frequency of the equalizer stages in the range of 170...7000Hz.
- **MID1 Q, MID2 Q (10...100):**
Adjusts the resonance (Q) of the equalizer stages in a range of 1...10.
- **MID1 BOOST, MID2 BOOST (-20...+20):**
Boosts or cuts the equalizers by up to 20dB.
- **TREBLE FRQ (0...127):**
Adjusts the frequency of the treble shelf filter in the range of 2000...7000 Hz.
- **TREBLE SLOPE (0...127):**
Adjusts the steepness of the treble filter in the range of 3...10dB/octave.
- **TREBLE BOOST (-15...+15):**
Boosts or cuts the treble up to 15dB.

The Equalizer section has an optional graphical view too (see the [screenshot](#) at the beginning of the Effects Block).

Above the Equalizer panel there are two small icons:



The left one selects the panel with sliders (described above); the right one selects the panel with the graphical view. The icon for the currently-selected panel type is illuminated in red.

Using the mouse within the graphical view, you can adjust the frequency of a filter stage by clicking and dragging the yellow dot left and right.

You can similarly adjust the boost/cut by clicking and dragging up and down.

Using the right mouse button to click and drag (either left-right or up-down), you can adjust the steepness of the low and high shelving filters in dB/octave and the Q value of the mid filters.

Note: You can only assign an EQ parameter as a destination for a Flexi Controller from within the *slider-based* panel. As soon as an EQ parameter has been assigned as a Flexi destination, the graphical EQ panel will be disabled for as long as the assignment remains in place. (See the section on [Flexi Controllers](#) below for a detailed explanation of their function.)

Effect 3: Chorus

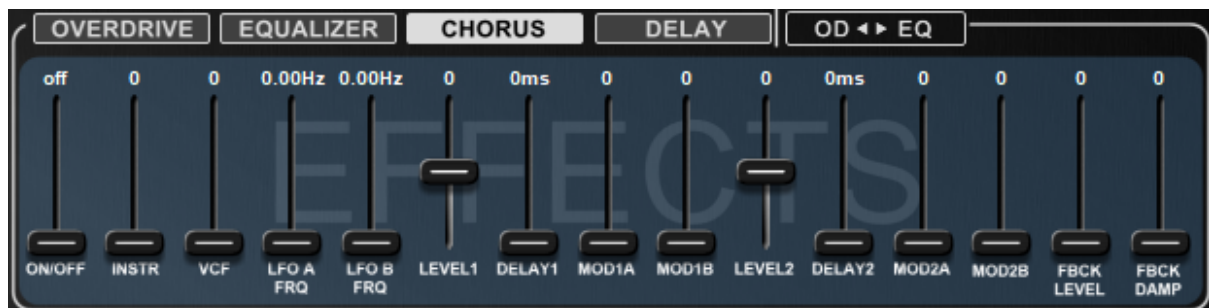

This effect is very flexible; in addition to Chorus, it can be configured as a Flanger, Slapback Echo or simple Reverb merely by setting the parameters differently.

It consists of two delay lines, which are copies of the incoming signal, and two LFOs. Both LFOs can modulate the delay times of both delay lines simultaneously by arbitrary amounts using four fully-independent modulation depth controls.

Here the delay lines are very “clean”, especially in comparison to those found in the [Delay](#) effect, and the maximum delay time is fairly short but with very fine control.

Since there are two delay lines and two LFOs, there are two identical sets of sliders. For simplicity they are paired together in the description below.

Moving from left to right, the sliders unique to this effect are as follows:

- **LFO A FRQ, LFO B FRQ (0.00Hz...8.60Hz):**
Adjusts the frequency of the two LFOs.
- **LEVEL1, LEVEL2 (-64...63):**
Adjusts the output level of the two delay lines. The amplitude can be negative, which is important for flanger sounds if the delay value is very small, or if the two delay values are very close to each other.
- **DELAY1, DELAY2 (0ms...140ms):**
The delay time can be adjusted here in steps of approximately 1.1ms up to the maximum value of 140ms. You will need to ensure that the combination of delay and modulation settings remains within a usable range.
- **MOD1A, MOD1B, MOD2A, MOD2B (0...127):**
Adjusts the amount of modulation from LFOs A and B that is applied to the delay lines 1 and 2. Higher amounts result in the delay time being cyclically shifted further to either side of the value set by the two delay time sliders.
- **FBCK LEVEL (0...127):**
Adjusts the feedback level. A higher level increases the number of times the delay signal is repeated. You will need to set the feedback level appropriately to avoid oscillation. Oscillation can choke off the sound completely; if this happens, simply lower the feedback slider again.
- **FBCK DAMP (0..127):**
Adjusts the feedback damping. This is a lowpass filter applied to the feedback path. It can emulate the natural damping of walls in a room. It also helps prevent oscillation.

Note 1: LFO A and LFO B can be freely assigned to many other parameters when used as a control source with a Flexi Controller. (See the section on [Flexi Controllers](#) for a detailed explanation.)

Note 2: LFO A and LFO B *cannot* be synchronized to an incoming MIDI clock signal.

Effect 4: Delay



This is a tape-style delay. Unlike the Chorus, here the delay lines are much “darker” than the dry signal due to having a greater proportion of the high frequencies filtered out. It is a classic effect often used with synthesizers..

The functions of the Delay are identical to those of the Chorus except for the behavior of the DELAY1 and DELAY2 sliders and their maximum delay time. To avoid unnecessary duplication, we only describe their differences below.

- **DELAY1, DELAY2 (0ms...600ms | 1/16D, 1/8D, 1/4D, 1/16T, 1/8T, 1/4T, 1/16, 1/8, 1/4, 1/2, 1/1):**

By default, the delay sliders can be adjusted in steps of either 4 or 5 ms up to the maximum of 600ms.

However, either Delay1 alone, or both Delay1 and Delay2 together can be **synchronized to an incoming MIDI clock signal**. When the SYNC slider in the [MIDI Block](#) is set to *Delay1* or *Delay1+2* then the synchronized slider changes from a millisecond readout to a note-length readout as detailed above. The plain numbers indicate respectively a sixteenth note, an eighth note, a quarter note, a half note and a whole note. A “D” after the number indicates a dotted note and a “T” indicates a triplet.

As before, you will need to ensure that the combination of delay and modulation settings remains within a usable range. Particular care must be taken if choosing to modulate the DELAY1 and DELAY2 sliders with a [Flexi Controller](#); when making quick, discrete changes to the delay time, the results can be very musical; however, making continuous adjustments can sometimes lead to some unpleasant artefacts.

Note 1: The range of MIDI Sync is 30-480 BPM. If the incoming clock signal is outside that range then it will be limited to the border value closest to it. (A program that uses MIDI Sync defaults to 120 BPM if no MIDI clock signal is detected at the point it is loaded.)

Note 2: If the combined setting of the BPM value of the incoming MIDI clock and the note value of a delay slider would result in a delay time that exceeds 600ms, then the delay will be limited to 600ms.

Note 3: The DELAY1 and DELAY2 sliders are reset when switching between the Chorus and Delay and vice versa.

Tap Tempo

This feature is exclusive to the Delay effect and functions in the following way: the Tap Tempo sets the speed of the delay repeats on the DELAY1 line. The delay repeats of the DELAY2 line are automatically set to twice the speed of the DELAY1 line.

To activate the Tap Tempo, first engage the [Tuner](#) then tap the Program footswitch four times in tempo. If the taps were accurate, then the rightmost decimal point in the FI4's display will light up. Bear in mind that, because this action is carried out with the Tuner engaged, no sound will be heard: disengage the Tuner to hear the result.

To cancel the Tap Tempo and return to the stored delay settings of the program, engage the Tuner again and press the Program footswitch once. The decimal point will go dark again.

Tap Tempo is automatically cancelled whenever a program change occurs.

Fewer than four taps or uneven tapping will fail to activate Tap Tempo, or will disable it if it was already engaged at the time of tapping.

The range of Tap Tempo is 50-400 BPM.

A Tap Tempo of below 100 BPM exceeds the range of the available maximum delay time. To overcome this, the Delay1 repeats will be automatically doubled so they fit; accordingly the DELAY2 repeats will be set to twice the speed of DELAY1.

The decimal point Tap Tempo indicator will temporarily disappear from the display when the Tuner is being used for tuning but will reappear as soon as the audio signal stops.

Tap Tempo can also be set using the dedicated [MIDI commands](#) for the Tuner and for Program Up and it functions in exactly the same way as described above.

Note: While Tap Tempo is engaged, it overrides MIDI Sync of the delay lines; it has no effect on MIDI Sync of LFO4. Once disengaged, the delay lines respond to the MIDI clock again.

Adjusting Effects with the PARAMETER and EDIT Dials

Setting the DATA digit on the FI4's display to default (0) using the EDIT dial will reproduce the effects settings exactly as they are saved in the program file data.

The EDIT dial will *only* adjust the *last active* effect in the chain.

When **OVERDRIVE** is last in the chain, turning the EDIT dial towards maximum will increase DRIVE; turning towards minimum will decrease it.

When **EQUALIZER** is last in the chain, the EDIT dial functions as a “tilt EQ”. Turning the EDIT dial towards maximum will simultaneously boost the treble and cut the bass (leaving the mid controls unchanged); turning towards minimum will simultaneously cut the treble and boost the bass. So effectively, turning the EDIT dial to a higher value will make the sound sharper, whereas turning it to a lower value will dampen the sound.

When **CHORUS** or **DELAY** is last in the chain, turning the EDIT dial towards maximum will increase both the INSTR and VCF blends; turning towards minimum will decrease them.

Flexi Controllers



The four Flexi Controllers constitute what is sometimes referred to as a “modulation matrix” and provide a way to control almost any slider-based parameter in the Editor in a very flexible and intuitive way from a choice of control sources.²⁰

What does this mean? Well, one example of a control source is an envelope and earlier we talked about the FI4's VCF envelope. If you remember, this controls a fixed destination, namely the cutoff frequency of the filter. Now, using a Flexi Controller, you can take that VCF envelope and send it to almost any additional destination of your choosing, for example the pitch of an oscillator, the speed of the LFO, the grade of the distortion, even the decay stage of the VCF envelope itself!

The power of Flexi Controllers opens up a truly mind-blowing number of possibilities for creating complex, highly-expressive and unique sounds, limited only by your imagination and your willingness to experiment. The process of setting up a Flexi Controller assignment is a

²⁰ The following sliders cannot be controlled by Flexis: ON/OFF of the four Effects; INSTR and VCF of the EQ and Overdrive; TRANSPPOSE VOICE2 and VOICE3 of the Harmonizer section; VCF TYPE and PITCH FOLLOW of the Filter section; ENV MODE of the Envelopes Block; SYNC, KBD PRIORITY, MIDI OUT, PC, TRANSP and PBD RANGE of the MIDI Block.

relatively simple one and basically consists of choosing a source and a destination. There are then a few choices to be made which alter how and to what degree the source modulates the destination. This will all be explained below later.

The four Flexi Controllers are situated towards the right in the upper portion of the Editor screen. Each has a different color to distinguish it from the others but all are identical in function.

The panel of each Flexi Controller has four windows and a pushbutton and these are as follows:

- **MODE (QUANTIZE/CONTINUOUS):**

Click this window to select whether the control source modulates the destination parameter either smoothly or in quantized steps.

e.g. If the destination is PITCH COARSE then CONTINUOUS will adjust the pitch smoothly, whereas QUANTIZE will adjust it in semitone steps.

- **SOURCE:**

Click this window to open a pop-up menu with the list of **Control Sources**:

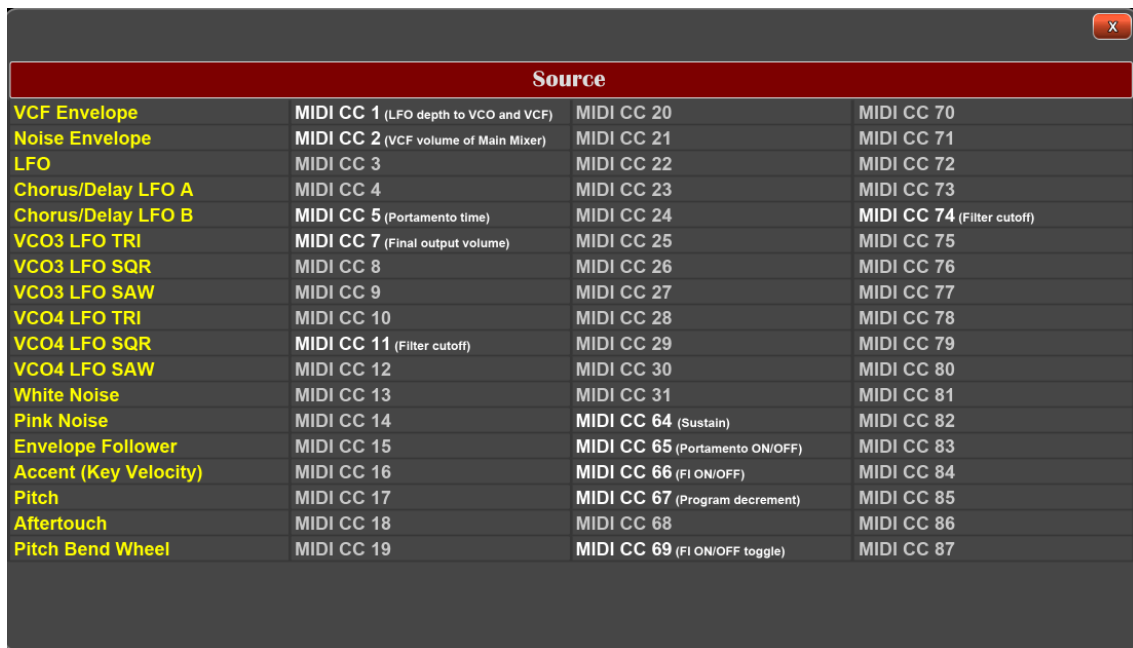

Source			
VCF Envelope	MIDI CC 1 (LFO depth to VCO and VCF)	MIDI CC 20	MIDI CC 70
Noise Envelope	MIDI CC 2 (VCF volume of Main Mixer)	MIDI CC 21	MIDI CC 71
LFO	MIDI CC 3	MIDI CC 22	MIDI CC 72
Chorus/Delay LFO A	MIDI CC 4	MIDI CC 23	MIDI CC 73
Chorus/Delay LFO B	MIDI CC 5 (Portamento time)	MIDI CC 24	MIDI CC 74 (Filter cutoff)
VCO3 LFO TRI	MIDI CC 7 (Final output volume)	MIDI CC 25	MIDI CC 75
VCO3 LFO SQR	MIDI CC 8	MIDI CC 26	MIDI CC 76
VCO3 LFO SAW	MIDI CC 9	MIDI CC 27	MIDI CC 77
VCO4 LFO TRI	MIDI CC 10	MIDI CC 28	MIDI CC 78
VCO4 LFO SQR	MIDI CC 11 (Filter cutoff)	MIDI CC 29	MIDI CC 79
VCO4 LFO SAW	MIDI CC 12	MIDI CC 30	MIDI CC 80
White Noise	MIDI CC 13	MIDI CC 31	MIDI CC 81
Pink Noise	MIDI CC 14	MIDI CC 64 (Sustain)	MIDI CC 82
Envelope Follower	MIDI CC 15	MIDI CC 65 (Portamento ON/OFF)	MIDI CC 83
Accent (Key Velocity)	MIDI CC 16	MIDI CC 66 (FI ON/OFF)	MIDI CC 84
Pitch	MIDI CC 17	MIDI CC 67 (Program decrement)	MIDI CC 85
Aftertouch	MIDI CC 18	MIDI CC 68	MIDI CC 86
Pitch Bend Wheel	MIDI CC 19	MIDI CC 69 (FI ON/OFF toggle)	MIDI CC 87

Click on a source to select it. The menu will close automatically.

To close the menu without selecting a source, click on the **X** or anywhere in the panels above the menu screen.

Aside from the bottom five, the yellow sources in the left column are *internal*; the rest are *external*. The MIDI sources in white have a [default assignment](#) within the FI4 (shown in brackets). Internal and external sources are discussed [further down](#).

- **RANGE CTRL:**

Click this window to open a pop-up menu with the list of **Range Controls**:

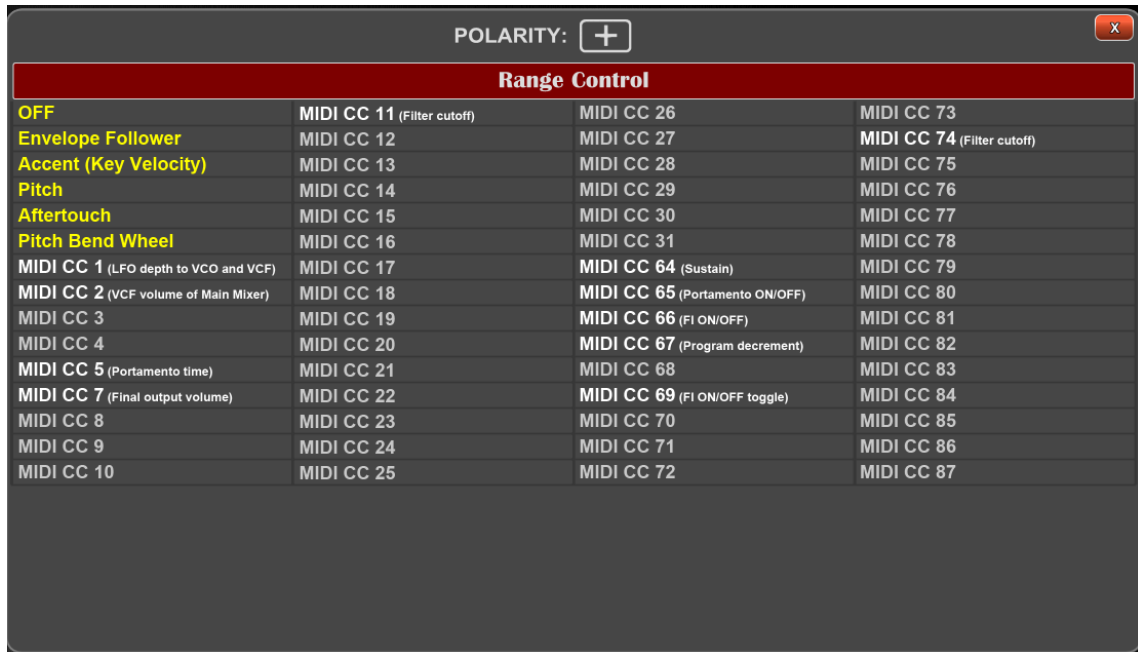

Above the list is a POLARITY button. This selects whether the range control is applied positively or negatively. By default it is positive (+). Click the button to change the polarity.

Click on a Range Control to select it. The menu will close automatically.

To close the menu without selecting a range controller, either select OFF, click the **X** or click anywhere in the panels above the menu screen.

Here all the sources shown are *external* ones; as before, those MIDI sources that have a default assignment within the FI4 are shown in white with the name following it in brackets.

A Range Control is used to give you real-time, direct live control over the depth of modulation from the source to the destination.

e.g. If the Range Control is PITCH, then the modulation depth from the control source will change according to whether you play in the lower register or the higher register of your instrument.

Continuing the example, if the polarity is *positive* (+) then modulation will increase as you play from low to high. By contrast, if the polarity is *negative* (-), the behavior is reversed.

Range Control is explained in a bit more detail [further below](#).

- **CURVE:**

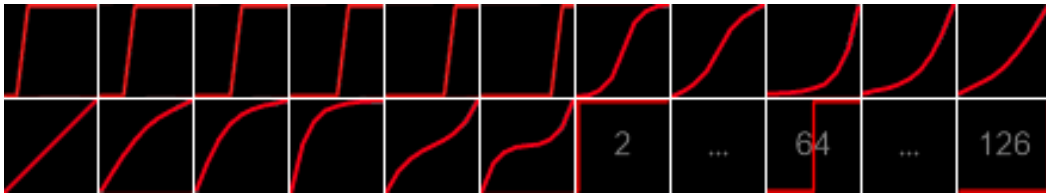

Click and drag up and down in the window to select one of the Flexi Controller's eighty available transformation curves. Double-click it to reset it to the default linear curve.

The numbered curves (2-126) are of the hard-split type; each of these curves will allow you to create a split point between any two adjacent semitones within a circa 5-octave range. See the [Flexi Split Curves Lookup Table](#) to see which number corresponds to which note.

The various curves alter how the modulation from the control source is applied to the destination. e.g. If the control source is PITCH and the destination is DRIVE then using a *linear* curve will cause the distortion to increase evenly as you play chromatically up through the range of your instrument. By contrast, using an *exponential* curve will cause the distortion to be applied only slightly at the lower range of your instrument but it will be increased more dramatically towards the upper range.

- **LEARN/CLEAR:**

Click the LEARN pushbutton to **assign a destination** to the Flexi Controller. The button will begin blinking to indicate it is waiting for a destination to be chosen. Click on a parameter's slider to select it as a destination and the button will remain lit. (If no destination is chosen within 10 seconds, the blinking light will time out.)

When clicked, the single slider will split into two, forming a *pair* of sliders whose color matches that of the Flexi Controller slot used. The position of the left slider determines the base (unmodulated) value of the parameter (i.e. it functions *exactly* as the normal, non-split slider did). The position of the right slider, which can be set above or below that of the left, determines the *maximum deviation from the base value* when the modulation from the control source is at its maximum amplitude; it also determines the *direction* of the modulation.

e.g. If the Flexi Controller's control source is an LFO and its destination is PITCH COARSE, then setting the left slider to 0 and the right slider to 12 will cause the pitch to be one octave higher than the base pitch when the LFO is at the *peak* of its cycle.

Staying with this example, then setting the right slider *above* the left will cause the pitch to *rise* as the LFO rises. Conversely, setting the right slider *below* the left will cause the pitch to *fall* as the LFO rises.

At the instant the two sliders first appear, they both have the exact same value. When adjusting the left slider, both sliders move together, continuing to share the exact same value. By contrast, when adjusting the right slider, the left slider does not move.

After setting the right and left sliders to different values, adjusting the left slider will again cause both sliders to move together, always maintaining the set distance between them. If, however, while adjusting the left slider, the right slider hits the upper or lower limit of its travel, then continuing to move the left slider in the same direction will cause the distance between the two sliders to become compressed. This compressed range will now be “remembered”; when moving the left slider back in the other direction again, this new, shorter distance between the two sliders will be maintained. To increase the distance again, adjust the right slider.

By default, the value displayed above the paired sliders is that of the left slider. Clicking on and moving the right slider will cause *its* value to be displayed instead for as long as the slider is kept in motion. Upon coming to rest, the slider’s display will revert to default after a short delay.

To delete a destination assignment, click the red CLEAR button in the Flexi panel.

Note 1: It is not possible for a single destination to be assigned to more than one Flexi Controller. If you try to assign a second Flexi Controller to a slider that is already assigned, then the new assignment will overwrite the old one.

Note 2: You can only assign an [EQ](#) parameter as a destination for a Flexi Controller from within the *slider-based* panel. As soon as an EQ parameter has been assigned as a Flexi destination, the graphical EQ panel will be disabled for as long as the assignment remains in place.

Remember: you can make use of the [Flexi Copy Tool](#) to copy the settings of one Flexi Controller to any other(s).

A Flexi Controller in Action

There is a lot of information to absorb from the previous section, so let’s try to consolidate it by working through an example. We’ll set up an assignment and play around with the various settings to hear what they do. Let’s use a Flexi Controller to create a 4-semitone pitch sweep of an oscillator:

First, set up a simple sawtooth sound on VCO1 and VCO2.²¹ Set VCO1 PITCH COARSE to 12. Set the filter VCF TYPE slider to OFF. When you play a note, you should hear the two oscillators pitched an octave apart.

Select the NOISE ENVELOPE as Flexi 1's source via the SOURCE window. Set the ATTACK of the noise envelope to minimum and its DECAY to 110.

Now assign Flexi 1 to VCO1 COARSE by first clicking on the LEARN button in the Flexi 1 window and then clicking on the VCO1 COARSE slider. Set the left slider to 12 and the right slider to 16.

Make sure mode is set to QUANTIZE by clicking in Flexi 1's MODE window.

Select a linear curve from the curve window by dragging the graphic.

Now, play a C and you will hear that VCO2 plays a steady C, whereas VCO1 plays chromatically from E down to C.

Change the MODE to CONTINUOUS. Now when you play, the pitch will drop down smoothly instead.

Move the right slider from 16 down to 8. Now when you play, the pitch of VCO1 starts at C and moves up to E.

Adjust the right slider to 24 to get a full octave sweep. Set MODE back to QUANTIZE and choose a few of the different curves. Notice how the timing of the pitch sweep changes as you play using the different curves.

More on Flexi Range Control

In the above example, you may have noticed that, interesting as they were, the modulations we set up using the Flexi controller caused the sound to repeat the same way each time we played a note, using any given setting. This is because we used an envelope; an envelope, along with the LFOs and noise sources, belongs to a group of sources that we cannot control directly as we play. These are known as *internal* sources. In the FI4, there is also a group of *external* sources and these sources *are* under our direct control as we play. The group consists of the Envelope Follower, Accent, Pitch, Aftertouch, Pitch Bend Wheel, or any assignable MIDI CC.

Any external source can be used as a Range Control. A Range Control allows us to manually limit the amount of modulation applied from the control source to the destination.

²¹ This is covered in [Building Your First Sound](#); for now, just press [INIT](#) and [COPY](#) VCO1 to VCO2.

Turning back to our example, we could for instance use an expression pedal sending out MIDI CC1 to control, in real time, how much the noise envelope affects the pitch of VCO1.

As you already know, a Range Control can act with either positive or negative polarity:

With *positive* polarity (+) , then, when the range control is at 127, the control source will be completely uninhibited and will act with maximum amplitude upon the destination. By contrast, when Range Control is at 0, the modulation will be suppressed.

With *negative* polarity (-), then, the reverse happens; when Range control is at 0, the control source will be uninhibited and will act with maximum amplitude upon the destination. By contrast, when Range Control is at 127, the modulation will be suppressed.

Special Flexi-Only Modulation Sources

There are eight modulation sources in the list which can *only* be used with Flexi Controllers - they are not found elsewhere in the Editor. Six are LFOs and two are noise sources. They are explained below.

- **VCO3/VCO4 LFO (TRI/SQR/SAW):**

Each of these two LFOs has three waveforms - saw, square and triangle. To conserve precious space in the Editor, some sharing of sliders has become necessary: the LFOs' frequencies and pulse widths are adjusted by using the LFO FRQ and OFFSET sliders from the PULSE WIDTH sections of VCO3 and VCO4. Note that moving any of these four sliders will result in *both* parameters assigned to it being adjusted simultaneously.

In order to have many different applications using a broad range of frequencies, VCO3 LFO is four times faster than VCO4 LFO. (See the [LFO Frequency Lookup Tables](#) in the Appendix for details of the actual frequencies).

VCO3 LFO is free-running, whereas VCO4 LFO is synchronized to the trigger event: whenever you play a new note, the phase of VCO4 LFO will be reset.

Note: The PULSE WIDTH OFFSET behaves differently than might otherwise be expected when used to control the pulse width of the VCO3/VCO4 LFOs. Ordinarily, when PULSE WIDTH OFFSET is used to control the square waves of the VCOs, the waveform is symmetrical at 0 and is a narrow pulse at 127. By contrast, when PULSE WIDTH OFFSET is used to control the pulse width of the VCO3/VCO4 LFOs, it is symmetrical (50% duty cycle) at 64; settings of 0 and 127 equate to duty cycles of approximately 10% and 90% respectively. See the diagram below:

Pulse Width Settings

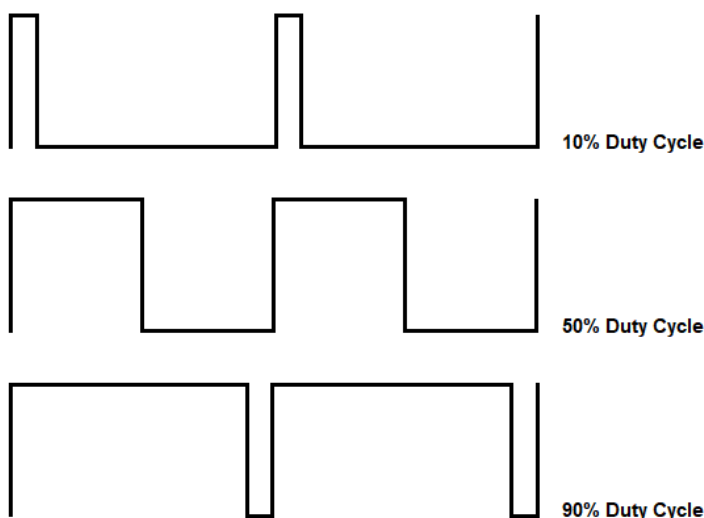

- **White Noise and Pink Noise:**

The white noise generator generates random, non-consecutive values. The noise is sampled at the frequency of VCO3 LFO. When used with a Flexi Controller set to *continuous*, this can be used to modulate pitch or filter cutoff for classic sci-fi computer *sample-and-hold* effects. However, if you use it to control the pitch of a VCO, but set the Flexi Controller to *quantized*, then you get something resembling a random arpeggio played at the speed of the VCO3 LFO.

The pink noise generator is lowpass-filtered white noise, so the range of generated random values is narrower than those of the white noise generator. The cutoff of the filter is adjusted via the VCO4 LFO frequency slider. A higher cutoff lets more values through from the higher regions, which gives the impression of an increase in speed. You can use the pink noise in a similar way to a triangle or sine-wave LFO, but the vibration is irregular and moves around completely randomly.

Note: The cutoff control for the filter of the pink noise generator is *not* adjusted when the VCO4 PULSE WIDTH LFO FRQ is assigned as a Flexi destination; only the two LFOs under that slider's control will be adjusted. Consequently, access to the pink noise filter cutoff parameter is inhibited whenever a Flexi is assigned to that slider. Pink noise is also affected when LFO4 MIDI Sync is enabled; see note 2 of the next section for details.

MIDI Clock Sync of LFO4

The frequency of VCO4 LFO can be synchronized to the tempo of an incoming MIDI clock signal via the SYNC slider in the [MIDI Block](#), though its phase will still reset with each new note played.

When the SYNC slider is set to *LFO4* in the MIDI Block, the **PULSE WIDTH LFO FRQ** slider of **VCO4** changes from a 0...127 readout to a note-length readout as shown below:

- **PULSE WIDTH LFO FRQ (1/1, 1/2, 1/4, 1/8, 1/16, 1/32, 1/4T, 1/8T, 1/16D, 1/16T, 1/4D, 1/8D, 1/16D)**: The plain numbers indicate respectively a whole note, a half note, a quarter note, an eighth note, a sixteenth note and a thirty-secondth note. A “T” after the number indicates a triplet and a “D” indicates a dotted note.

Note 1: The range of MIDI Sync is 30-480 BPM. If the incoming clock signal is outside that range then it will be limited to the border value closest to it. (A program that uses MIDI Sync defaults to 120 BPM if no MIDI clock signal is detected at the point it is loaded.)

Note 2: When LFO4 MIDI Sync is switched on or off, the VCO4 PULSE WIDTH LFO FRQ slider is reset to its minimum position. Consequently, the other parameters that are sharing this slider are also reset to their minimum values, namely the cutoff of the filter for the pink noise and the actual pulse width LFO frequency of VCO4. Furthermore, whenever LFO4 MIDI Sync is active, the ranges of both the pink noise filter cutoff parameter and the actual pulse width LFO frequency of VCO4 are limited to steps 1-12 of the usual 127.

Some Ideas for Uses of Flexi Controllers

Here are just *some* examples of the ways in which Flexi Controllers could be used to create interesting sounds and effects sounds on the FI4:

- Set up two notch filters using the MID FREQ controls in the graphical EQ panel then assign LFO to sweep both mid frequencies to mimic a 4-stage phaser;
- Use the EQ to create two peaks similar to as described above but instead control with the VCF envelope (alongside the filter(s)) to create 3- and 4-peak filters;
- Use an envelope to raise the volume of an oscillator to push it into foldover distortion; This can give sounds which sound similar to those made using “hard-sync”;
- Make a sound’s character change completely depending on which register it is played in - perhaps guitar-only in the lower register, synth-only in the upper register;
- Set different coarse tunings on the VCOs to create chords and then use a MIDI CC or ACCENT assigned to VCO PITCH COARSE to change chord quality on the fly;

- Route an expression pedal (via a MIDI CC) to VCO TRANSPOSE with a setting of 12 or 24 semitones to create a whammy pedal effect for the oscillators;
- Create asymmetrical LFO behavior by using an LFO as a control source and selecting a non-linear transformation curve to act on the destination;
- Use a MIDI CC command to change between the available clock-sync note lengths for the Delay or LFO4 during performance;
- Introduce a delay signal via expression pedal or via your playing dynamics;
- Assign the VCF envelope or the Noise envelope to one of the pitch sliders to create a “pitch blip” at the beginning of a note to mimic the attack of a brass instrument;
- Assign the VCF envelope or the Noise envelope to the coarse pitch slider of VCO2 and turn on Oscillator Sync to get harmonically rich sweeps;
- Assign a slow LFO to pitch with a low modulation amount to pitch or envelope parameters to simulate the natural drift of analog synthesizer circuitry components;
- Assign the envelope follower to the frequency of an LFO to speed up or slow down the LFO with your playing dynamics;
- In conjunction with the Sustain feature, assign LFOs to various parameters to creating an ambient drone with a constantly evolving texture;
- Assign square wave LFOs to PITCH COARSE and/or VCO VOLUME sliders using different PULSE WIDTH OFFSET values for each LFO to simulate an arpeggiator;
- Create complex expression morphing of a sound by having four parameters be affected by the pedal sweep. Even once you’ve set the parameter values with the sliders, which will fix the combination of values at the two extremities of the pedal’s travel, you can still experiment further by adjusting the curves, which will change the combination of values at each of the points in between those extremities.

MIDI Controllers as Flexi Controller Sources and Range Controls

If, when selecting a Flexi source or a Range Control, you choose a MIDI controller that has a default assignment in the FI4, then that default assignment will be overridden.

The default assignments and their respective default values are shown below:

MIDI CC / Name	Default Assignment in the FI4	Default Value
1	Pitch/filter vibrato	0 ²² /127
2	3rd (logarithmic) VCF volume of Main Mixer	127
5	Portamento time	0 ²³ /127
7	Main output volume	127
11	Filter cutoff	64
64	Sustain	0
65	Portamento ON/OFF	127
66	FI4 ON/OFF	---
67	Program decrement	---
69	FI4 ON/OFF toggle	---
74	Filter cutoff	64
Pitch Bend	Pitch bend	---
Aftertouch	Aftertouch	---
Velocity	Keyboard velocity control of filter cutoff in MIDI mode	---

The default values are recalled (all of them at once) when one of the following occurs:

1. The FI4 is powered on;
2. The Editor changes one of the Flexi sources;
3. A Program Change.

²² Synth Mode only.

²³ EWI Mode only.

MIDI

Setting the MIDI Channel

The MIDI channel setting dictates both the FI4's response to incoming MIDI messages and its behavior when generating MIDI note messages via the new [MIDI Triggering](#) feature.

The MIDI channel can be set to a number between 1 and 16 or it can be set to "ALL".

When set to a number between 1 and 16, the FI4 will only respond to messages received on that channel. It will also send out Program Changes and MIDI note messages on that channel only.

When set to "ALL", the FI4 will respond to messages received on all 16 channels. However, when sending out Program Changes and MIDI note messages, it will do so on channel 1 only.

Setting the MIDI channel is done via the [Global Menu](#).

MIDI Thru

When MIDI Thru is enabled, the MIDI OUT of the FI4 will pass on all information from its MIDI IN (with the exception of CC6 (Data Edit), NRPN controllers and SysEx data).

If MIDI Thru is enabled whilst using the [MIDI Triggering](#) feature, then any MIDI CC messages intended for the FI4 will also be sent on to (and potentially affect) the external synthesizer. If you only want to control things like modulation, [Expression](#) and [Sustain](#) on the FI4 but not on the external synthesizer, then you must disable MIDI Thru.

MIDI Thru also has a bearing on the behavior of Program Change messages being sent out (see below for details).

MIDI Thru is enabled or disabled via the [Global Menu](#).

Program Change Out

Program Change out behavior in v4.11 differs slightly from previous versions due to the addition of the new [MIDI Triggering](#) feature. The new behavior is summarized below.

When changing presets on the FI4 using the PROGRAM footswitch, the EDIT/BANK UP dial or MIDI CC messages²⁴, then the following occurs:

- If the MIDI OUT slider in the [External MIDI Tab](#) is set to OFF, then the FI4 will send out the PC number of the currently-selected FI4 patch;
- If the MIDI OUT slider is set to ON, then the FI4 will send out the PC number as set by the PC slider in the [External MIDI Tab](#).

When changing presets on the FI4 by sending a PC message, then the following occurs:

- If the MIDI OUT slider in the [External MIDI Tab](#) is set to ON, then the FI4 will send out the PC number as set by the PC slider in the External MIDI tab;
- If the MIDI OUT slider is set to OFF and [MIDI Thru](#) is enabled, then the FI4 will pass on the incoming PC number to the MIDI Out port;
- If the MIDI OUT slider is set to OFF and MIDI Thru is disabled, then the FI4 will not send out any PC message at all.

Note: When the FI4 sends patch change information to the external synthesizer, it only sends standard PC messages; it does not send Bank Select messages. Therefore, if your external synthesizer has more than 128 presets (i.e. a preset structure that makes use of Bank Select messages), then you'll need to ensure that the external patches you intend to use with the FI4 are situated within an accessible PC range. (For example, some synthesizers that have 200 patches are arranged in 5 banks of 40 patches; these are accessed using PCs 0-39 within a given bank.) Alternatively, you could manually switch banks on the external synthesizer or send Bank Select messages to it from an external MIDI controller.

²⁴ See the [MIDI Implementation](#) chart for the dedicated FI4 MIDI CC messages for Program Up/Down and Bank Up/Down.

MIDI-Related Performance Features

Expression

By default, an expression pedal (or keyboard mod wheel) sending CC1 controls the depth of the LFO to the VCO and the VCF as detailed in the [LFO Block](#). As mentioned in previous sections, there are various other parameters available for expression control, such as filter cutoff, synth volume, input instrument volume, master volume and portamento time. Please see the MIDI Implementation chart on the next page for details. Furthermore, by making use of [Flexi Controllers](#), it is possible to control many more parameters via expression.

Sustain

The synth sound of the FI4, i.e. the VCF output of the Main Mixer, can be made to sustain indefinitely; it is then possible to play over the top of this using the input instrument without triggering changes of pitch. Sustain is switched on and off via MIDI CC64. See the MIDI Implementation chart on the next page for details. Sustain can also be used via a MIDI keyboard and likewise prevents further triggering of notes from the keyboard when engaged.

The Sustain function “freezes” the synthesizer pitch but does not freeze the VCF frequency (filter cutoff). This is a desirable feature as it allows continued movement of the sound even after the sustain has been engaged. Once Sustain has been engaged, the envelopes in the [Envelopes Block](#) can no longer be triggered, however, their decay stages will continue until they reach their respective sustain levels.

Though the envelopes can no longer be triggered, the same is not true of the Envelope Follower; in Bass, Guitar and Split Instrument Mode, the VCF FREQUENCY will still respond to the volume envelope of the input instrument signal. If you do not want the filter cutoff to react to input dynamics, then the ENV FOLLOW and ACCENT sliders must be set to zero. By the same token, if you do want the filter cutoff to react to playing dynamics (and this can yield some very nice results) then the ENV FOLLOW or the ACCENT slider must be set to a non-zero value.

The synth sound sustains at the volume level set by the VCA SUSTAIN parameter in the Envelopes Block, therefore, if you want a sound that sustains indefinitely, you will have to set this parameter to a non-zero value, otherwise it will eventually decay to silence. Attention also needs to be given to making sure that the combination of the VCF SUSTAIN and FREQUENCY parameters allows sound to be audible.

The Sustain continues until its MIDI OFF command is sent or a program change occurs.

Note: Sustain does not “freeze” the output from the Effects Block, only the Main Mixer output of the VCF, so the delay lines cannot be sustained.

MIDI Implementation

The FI4 will respond to the following standard MIDI messages received on the selected MIDI channel:²⁵

MIDI CC / Name	Default Function in the FI4	Default Value	Notes
Note On		---	Active only in SYNTH and EWI Mode.
Note Off		---	Active only in SYNTH and EWI Mode.
Aftertouch		---	
Velocity	Keyboard velocity control of filter cutoff	---	Active only in SYNTH and EWI Mode.
Pitch Bend		---	Active only in SYNTH and EWI Mode.
Program Change		---	PCs 1...99 select FI4 programs 1...99. (Uses the 0-127 convention; 0 is unused.)
1	LFO depth to VCF and VCO	0*/127	*0 in SYNTH Mode only. Modulation (CC1) is routed to both VCF and VCO LFO Modulation. The depth set in the program will be reached if CC1 is at maximum (127).
2	VCF volume of Main Mixer	127	Adjusts (logarithmically) the VCF volume of the Main Mixer. When CC2 is at maximum (127) then VCF volume of Main Mixer corresponds to the preset value in the program. This differs from Volume Control (CC7) in two aspects: <ul style="list-style-type: none"> 1. It only adjusts the synth volume, it does not change the input instrument's volume; 2. It is located <i>before</i> the effects, so delay trails, etc. will not be muted when CC2 is at 0.

²⁵ When using our midiBeam 4Control as a MIDI interface to connect to the FI4's Editor, the MIDI signals from any expression pedals and switches plugged into 4Control will be passed directly to the FI4. (Please see the [midiBeam 4Control User Manual](#) for full details.)

5	Portamento time	0*/127	*0 in EWI Mode only. When CC5 is at maximum (127) then this corresponds to the portamento value set in the program via the PORTA TIME slider in the Editor.
7	Final output volume of FI4	127	Controls the <i>entire</i> audio output of the FI4 (including any delay trails, etc). It is independent of all program parameters. It is smoothed and acts logarithmically. Beware: if you use a keyboard or a MIDI pedal to adjust the volume of the FI4 and you disconnect it, the volume will only return to the default maximum value if you power the FI4 off and on again, change program or change one of the Flexi sources in the Editor.
11	Filter cutoff	64	Duplication of CC74. See below.
64	Sustain ON/OFF	0	If ≥ 64 then it switches ON; If < 64 , then it switches OFF. Sustain stops upon change of program.
65	Portamento ON/OFF	127	If ≥ 64 then it switches ON; If < 64 , then it switches OFF.
66	FI4 ON/OFF	---	If ≥ 64 relay switches to ON. If < 64 , relay switches to OFF. (This message will also disengage the Tuner, putting the FI4 into either the ON or OFF state, depending on the value of the message sent.)
67	Program DOWN	---	If ≥ 64 then the program number first steps down by one, then it starts scrolling (as when holding the Program footswitch). If < 64 then it stops again.
69	FI4 ON/OFF toggle	---	If ≥ 64 then the FI4 flips between ON and OFF. If < 64 then the message is ignored. (If the Tuner is active then sending this message will disengage the Tuner and put the FI4 into the OFF state.)
74	Filter cutoff	64	Deviates ± 1 , ± 2 or ± 4 octaves from the cutoff value set by the VCF FRQ slider in

			<p>the program.</p> <p>Range is set by VCF CONTROL RANGE in the Global Menu.</p>
88	Program UP / Tap Tempo input	---	<p>For Program UP, if ≥ 64 then the program number first steps up by one, then it starts scrolling (like when holding the Program footswitch). If < 64 then scrolling stops again.</p> <p>When the Tuner is engaged then values of ≥ 64 send a tap to the Tap Tempo function. If < 64 then the message is ignored.</p>
89	Tuner ON/OFF toggle / Tap Tempo entry mode ON/OFF toggle	---	<p>If ≥ 64 then the Tuner flips between ON and OFF. If < 64 then the message is ignored.</p> <p>Whenever the Tuner is disengaged, the FI4 reverts to the ON state (just as using the ON/OFF footswitch does). (CCs 66 and 69 will also disengage the Tuner. See above.)</p>
90	Bank UP	---	<p>If ≥ 64 then the bank number steps up by 1. If < 64 then the message is ignored.</p>
91	Bank DOWN	---	<p>If ≥ 64 then the bank number steps down by 1. If < 64 then the message is ignored.</p>
92	INSTR volume of Main Mixer	127	<p>When at maximum (127) the INSTR volume corresponds to the preset value in the program.</p> <p>This is logarithmic and <i>before</i> the Effects Block, so delay trails etc. are <i>not</i> muted when CC92 is at 0.</p>
102	VCO Octave Transpose UP/DOWN	---	<p>Set a value of ≥ 64 on press and a value of < 64 on release.</p> <p>A short press will transpose the oscillators up an octave upon release.</p> <p>A longer press of 500ms will transpose the oscillators down an octave upon release.</p> <p>Transposition range is ± 2 octaves from the value stored in the program.</p>

			<p>Transposition is reset when switching to a new program.</p> <p>Note: If you want to use the separate Octave Transpose DOWN function below and/or want to have octave up transposition occur upon <i>press</i> rather than upon <i>release</i>, set your controller to send ≥ 64 and < 64 consecutively using a press action.</p>
103	VCO Octave Transpose DOWN	---	<p>Set a value of ≥ 64 on press and a value of < 64 on release.</p> <p>A short press will transpose the oscillators down an octave upon release.</p> <p>Transposition range is -2 octaves from the value stored in the program.</p> <p>Transposition is reset when switching to a new program.</p> <p>Note: If you want to have octave down shift occur upon <i>press</i> rather than upon <i>release</i>, set your controller to send only < 64 on a press action.</p>

Building Your First Sound

Loading a pre-existing sound and playing around with the various parameters can be a very good way to learn how to manipulate sounds to your liking, but at some point you will probably want to start creating your own sounds. This next section will give you a few pointers on how to do just that. The examples assume you are creating a sound using the audio input for triggering.

Connect the FI4 to your computer (a single cable is sufficient for this, unless you want to write your sound to the FI4 straightaway). Launch the Editor Suite and switch to the Editor view.

Let's start by zeroing out all the parameters so you can start from a clean slate. Using the [Block Reset Tool](#) in the lower-right corner of the Editor click **Select All** and **Reset**.

Synth Sounds

For synth sounds, we recommend only using a single oscillator at first until you have become familiar with the controls. Adding multiple oscillators adds complexity and you will need to be careful with the levels if you want to avoid [Foldover Distortion](#) and clipping. Note that due to the various gain stages in the signal path you may need to raise several sliders above minimum in order to hear anything.

To hear your dry instrument signal, turn up the INSTR slider in the Main Mixer. You should hear sound straight away (providing the pedal is not bypassed).

To hear a sound using the [Synth](#) you will first need to raise no less than 5 volume sliders! These are as follows:

1. At least one VCO waveform amplitude slider - e.g. VCO1 AMPLITUDE SAW;
2. That VCO's master volume - VCO1 AMPLITUDE VOLUME;
3. The synth volume going into the filter - VCF INPUT SYNTH;
4. The VCF outputs of the [Main Mixer](#) - MAIN MIXER VCF LIN *and*...
5. MAIN MIXER VCF LOG.

Switch to one of the two [ADSR envelope modes](#); you will now also need to set the [VCA envelope](#) before a sound can be heard. To start with, set the S slider to 127 and leave all others at minimum. This gives a simple on/off gate signal when playing a note. (If you wanted to use Vintage envelope mode then you would have to leave both the A and R sliders at minimum to achieve the same effect.)

Lastly, the [Filter](#) will need to be set with a sufficiently high cutoff to allow sound through. (You could set VCF TYPE to OFF to bypass it completely but for this example let's use the

filter.) Click the Slope button to set it to 24dB and raise the cutoff (VCF FRQ) slider to 122. You should now hear a sawtooth wave alongside the sound of your instrument. Lower the filter cutoff back down to 64 and you'll hear the sawtooth sound become more muted.

Now raise the A and D sliders of the VCF envelope to 64. This sets an envelope shape, though you still won't hear any difference until you apply this envelope to the filter. To do this, raise the AD/ADSR slider in the Filter section; set it to 64 for now. You should now hear a synth brass-type sound.

Experiment with the positions of the A and D sliders of the VCF envelope, the VCF FRQ slider, the AD/ADSR slider and the RESO slider to find a sound you like. If you want the filter to sustain at a cutoff level above that set by the VCF FRQ slider then raise the S slider of the VCF envelope. Also experiment with the position of the ENV FOLLOW slider to allow some control of the filter cutoff from your playing dynamics.

If desired, you could remove your dry instrument signal from the sound entirely by using the INSTR slider in the Main Mixer, or you could mix it in to taste. When you are satisfied with your creation, click **SAVE** to archive it to your computer.

Note: We wanted to show you the above method so that you fully understand the processes and signal paths involved in setting up a synth sound from scratch. Now that you have, you may be happy to learn that there is a shortcut to setting up a basic starting sound - simply press the **INIT** button in the [Program Display](#) to get an initialized patch of a single sawtooth oscillator (along with some dry input instrument signal in the Main Mixer).

Distortion Sounds

Now let's look at creating a sound using the [Distortion Block](#). Use the [Block Reset Tool](#) to zero out all the blocks again.

To hear a sound using the Distortion Block you will need to raise the following sliders:

1. At least one slider in the Harmonizer Mixer section - e.g. HARM MIX INSTR;
2. The Distortion Block signal going into the filter - VCF INPUT DIST;
3. The VCF outputs of the [Main Mixer](#) - MAIN MIXER VCF LIN *and*...
4. MAIN MIXER VCF LOG.

Again, if not bypassed, the [Filter](#) will need to be set with a sufficiently high cutoff to allow sound through. Let's bypass the filter this time so set the VCF TYPE slider to OFF.

At this point you should hear sound but it might be very faint. This is because the sound is being made using your instrument as opposed to the synth; the synth has a much hotter output than the instrument signal. If you recall, unity gain of the instrument input is achieved when its sliders are at 127. Turn the VCF DIST and HARM MIX INSTR sliders to 127. Now

also raise the DISTORTION TONE slider to 127 and you should notice a marked increase in volume. If it's still not enough, try raising the VCF LIN and VCF LOG sliders.

Now experiment with the positions of the DISTORTION GRADE and TONE sliders. You may need to back off some of the volume sliders at high GRADE settings.

Now raise the HARM MIXER VOICE2 VAR slider until you hear distortion at a 5th above the original sound. Adjust the HARMONIZER TRANSPOSE VOICE2 slider to hear the different intervals.

If desired, repeat the process with VOICE 3 and finally add in the VOICE1 slider. Experiment with different combinations, paying attention to the volumes, until you find a setting you like. You could also mix in some of your dry instrument signal using the INSTR slider in the Main Mixer. (If you wanted to, you could also switch the filter back on and adjust its settings and the VCF envelope settings as described above to further shape your sound.) When you are satisfied with the result, click **SAVE** to archive the sound to your computer.

Hopefully you now have a better idea of how to go about creating your own sounds. Remember that you can create a sound using a mixture of the [Synth](#) and the [Distortion](#) blocks. If necessary, go back over the explanations given in the [parameter block descriptions](#) to reacquaint yourself with what the various VCO, LFO and effects sliders do and begin experimenting; again stick to using a single VCO until you are comfortable with the controls. Don't be afraid to try things out - let your ears be your guide. Above all, have fun with it!

Tutorials

FI4 as a Replacement for Standard Single-Effect Pedals

As we mentioned all the way back in the introduction, the FI4 can perform the function of a number of single-effect pedals (sometimes more than one at a time). In this section we'll explain how to set up the pedal to achieve that via a few examples. Feel free to experiment and alter the settings used in the examples once you've tried them out.

FI4 as Envelope Filter

First let's look at how to program the FI4 as a standard envelope-controlled filter. For the purposes of this example, let's assume you are using a bass. Use the block adjust function to zero out all parameters.

For this effect, you will need to route your bass's output through the filter. Remember that unity gain is at 127 for the audio inputs. You will need to raise the following volume sliders:

[Go to Table of Contents](#)

1. The bass signal going into the filter - VCF INPUT INSTR;
2. The VCF outputs of the Main Mixer - MAIN MIXER VCF LIN *and...*
3. MAIN MIXER VCF LOG.

If you want to mix in some of your dry bass signal then raise the MAIN MIXER INSTR slider.

The filter will need to be set with a sufficiently high cutoff to allow sound through; start with 52. Keep the Slope on 12dB. Use the lowpass filter and set the resonance to about 30.

As you might guess from the name, an envelope-controlled filter makes use of the Envelope Follower to sweep the filter cutoff frequency. This might lead you to think that you simply need to turn up the ENV FOLLOW slider to get the desired result. However if you do, you'll find the results aren't particularly satisfactory. Much more pleasing results are obtained when you set an envelope shape using the AD or ADSR envelopes, allowing that to be the main driver of the filter cutoff, and then add a subtle amount of Envelope Follower to give some dynamic control, or even direct the Envelope Follower to the ADSR depth slider via a [Flexi Controller](#).

As a starting point, set the Envelope Mode to RESTART and set the VCF ADSR sliders to 50, 80, 50 and 1 respectively. Now, in the FILTER section, set the AD/ADSR slider to 45 and the ENV FOLLOW slider to 25. You should hear a much nicer result now.

Experiment with the positions of the ADSR sliders of the VCF envelope, the balance of AD/ADSR and ENV FOLLOW amounts, the filter type and slope and the resonance. You'll find there are many fantastic variations to be had. Also try adding some overdrive for a bit more bite post-filter or add some distortion pre-filter using the DIST slider of the VCF INPUT.

FI4 as Chorus

A chorus is achieved by taking the dry signal (instrument, synth or both) and then using a delay line to create a copy of that signal. The delay time of the copied signal is then modulated using an LFO which causes its pitch to fluctuate. When paired with the original signal in a 50/50 mix, the tuning differences create the characteristic shimmering sound.

Start by using just the dry instrument signal turned up to 127 in the Main Mixer. Switch on the Chorus section and raise its INSTR slider to 64 to give a 50/50 dry/wet mix. Chorus delay times are around 20-35ms. Set the DELAY1 slider to 25ms. Turn up the LEVEL1 slider to hear the delay; it is quite short so you may not perceive it very well. Now set a frequency on LFO A - start at about 4Hz. You won't notice any change until you turn up the MOD1A slider - set this to about 10. This will start to vary the delay time.

Experiment with the LFO A FRQ and the MOD1A amounts. To keep the results sounding musical, apply less modulation at fast LFO speeds; more modulation can be applied at low LFO speeds. You could also try adding a second delay line with different LFO and MOD settings to further thicken your sound.

FI4 as Flanger

A flanger is fairly similar to chorus but uses shorter delay times of around 5-15ms and the mix is mostly wet. It also typically uses feedback.

Again start by using just the dry instrument signal turned up to 127 in the Main Mixer. Set the Chorus INSTR slider to about 105, the LFO A FRQ to about 0.68Hz, the LEVEL1 slider to 63, the DELAY1 slider to 5ms and the MOD1A slider to about 30. Now set the FBCK LEVEL slider to about 100.

Experiment with negative settings of the LEVEL1 slider and with the LFO and MOD settings. Again, try adding a second delay line. When the delay times are quite short or close together, it can be useful to use LEVEL1 with a positive amount and LEVEL2 with a negative amount (or vice versa).

FI4 as Phaser

Using filtering, a phaser combines a dry signal with a phase-shifted version of itself. Any out-of-phase frequencies will then cancel each other out and create “notches” in the frequency spectrum. These notches are swept across the frequency spectrum using an LFO to give the characteristic swirling, swooshing sound.

This effect can be achieved on the FI4 by using the EQ section in conjunction with Flexi Controllers. Start by using just the dry instrument signal turned up to 127 in the Main Mixer. Switch on the EQ section and turn on its INSTR slider. Using the graphical EQ interface, space out the two yellow circles for the mid frequencies then drag both down to create two notches. Right-click and drag to change the width of the notches. Now switch to the slider EQ panel view and assign two Flexi controllers, one to each of the MID FRQ sliders, using a common LFO as their control source; set the same offset on both sets of split sliders so that the notches move in unison. (e.g. if MID FRQ1's left and right sliders are set to 0 and 40 respectively (an offset of 40) then, if MID FRQ2's left slider is set to say 60, then its right slider must be set to 40 higher, so 100.) Experiment with the frequency and shape of the LFO and with the depth, width and spacing of the notches.

To make the effect more dramatic, turn up the VCF INPUT INSTR slider, set VCF MODE to OFF to bypass the filter, turn up both VCF sliders of the Main Mixer and turn on the VCF slider in the EQ section.

FI4 as Tremolo

A tremolo effect involves rapidly varying the volume of your sound cyclically. This is quite a straightforward effect to achieve: use a Flexi Controller with an LFO as its source and a volume slider as its destination. The volume slider could be a single VCO's master volume slider or the volume slider(s) of the Main Mixer. By assigning different LFO shapes as the

source you can create a variety of tremolo effects such as a smooth sine wave or a choppy square wave. If you use VCO4 LFO then you can synchronize the tremolo to a MIDI clock.

FI4 as Vibrato

Vibrato is a simple cyclic pitch modulation of the input signal. It can be achieved in a similar way to the standard chorus we discussed above.

As with the other effects, start by using just the dry instrument signal turned up to 127 in the Main Mixer. Apply a 100% wet chorus signal by turning up the INSTR slider in the Chorus section to 127. Set LFO A FRQ to taste. Turn up LEVEL1 to 63. Either leave the DELAY1 slider at 0ms or raise it to a very low number such as 3ms. Now apply a low MOD1A amount of around 10 or lower. You can experiment with LFO speeds, MOD1A amount and the polarity of the LEVEL1 slider.

FI4 as Reverb

The reverb capabilities of the FI4 are quite limited given the lack of any special algorithms. That being said, it is possible to create some settings which are usable. We'll show some below, but feel free to experiment further, perhaps using the longer delay times of the new Delay effect.

Start by using just the dry instrument signal turned up to 127 in the Main Mixer. In the Chorus, set the INSTR slider to around 22. Now, starting with LFO A FRQ and moving to the right, set the remaining parameter sliders to the following two combinations:

- 0.27Hz, 0.61Hz, 63, 140ms, 25, 19, 63, 34ms, 27, 22, 54, 110
- 0Hz, 0Hz, 63, 140ms, 25, 0, 63, 34ms, 0, 0, 27, 110

FI4 as Delay

Due to its having dedicated sliders for both VCF and INSTR, the delay effect can be applied at differing depths to the synth and dry instrument signals. The controls are the same as for Chorus just with longer delay times and the availability of Tap Tempo and MIDI clock sync. Turn on the ON/OFF slider in the delay, set the LEVEL1 and DELAY1 sliders to maximum, set a non-zero amount on the INSTR and/or VCF slider and take it from there. Play around with the Tap Tempo and MIDI Sync settings. Just remember to keep the feedback in check with the FBCK LEVEL and FBCK DAMP sliders.

FI4 as Octaver

Many analogue octave pedals produce a square wave one octave down from their input signal and this can be done on the FI4 too. Program a square wave oscillator with coarse tuning of -12. (Add another square wave two octaves down if desired.) Then use the lowpass

filter with a static cutoff to remove the higher frequencies to taste. You can experiment with pulse width offset setting to further change the harmonic content of the sound. Try adding subtle envelope or envelope follower control to add bloom to the notes. Add EQ to beef up the bass if necessary. Mix in some dry signal at the Main Mixer to taste. You could take this idea further and use a Flexi Controller to be able to bring the dry signal in and out via an expression pedal or a button on a controller. You could also use the default CC11 or CC74 (or your own choice of CC) to adjust the filter on the fly.

FI4 as Pedal Wah

This is another quite straightforwardly achievable effect. As with the envelope-controlled filter, you will need to route the dry signal through the filter using the VCF INPUT INSTR slider and raise the VCF LIN and VCF LOG sliders in the Main Mixer. In theory you could use an expression pedal controlling CC11/CC74 to get a 2-, 4-, or 8-octave sweep of the filter (depending on the range set via VCF CONTROL RANGE in the [Global Menu](#)). In practice, this isn't defined enough; better results can be achieved by using a Flexi Controller with an expression pedal assigned to the filter cutoff (via any available MIDI CC) and specifying your own sweep range using the split sliders. Some famous wah-wah pedals use a bandpass filter instead of a lowpass filter so experiment to see which works best. You could try adding some resonance to add some variety. More dramatic results are possible when combined with overdrive and/or distortion.

Specifications

Technical specifications:

- Size: 155 x 125 x 65 mm (6.1 x 4.9 x 2.6 inch);
- Weight: 600g (1.32lb);
- Power: 9V stabilized, 200mA, Roland-Boss-type, center-negative supply (not included);
- True bypass (relay switching);
- Super-high-performance DSP;
- All algorithms calculated with 32-bit accuracy;
- 24-bit AD/DA converters;
- Oscillators generated at 512 kHz oversampling;
- Distortion calculated at 128 kHz oversampling.

Connectors:

- Audio in jack;
- Audio out jack;
- 5 pin DIN MIDI in;
- 5 pin DIN MIDI out;
- 1V/Octave CV and 5V/3.3V Gate outputs on MIDI out (via optional adapter cable);
- 5.5/2.1 mm DC socket for 9V stabilized, center-negative supply.

Controls:

- Input Level potentiometer;
- Output Level potentiometer;
- Parameter potentiometer;
- Edit dial for parameter editing;
- Bank Up pushbutton (on the Edit dial);
- Program Footswitch;
- On/Off Footswitch.

Displays:

- 3 VU meter LEDs, green: -18dB, yellow: -11dB, red: -5dB;
- On/Off indicator LED;
- 3-digit, 7-segment display: Bank Number, Program Number, Edit Data.

Features:

- Covers the full range of 24-fret 4-, 5- and 6-string bass guitars;
- 99 Programs; 9 Programs in Bank 0, 10 Programs in each of Banks 1...9;
- Factory Programs 21-29 are Deep Impact compatible;
- Sounds can be designed and archived with the PC/Mac Editor Suite software;
- Major sound parameters can be changed and saved easily on the device itself;
- Free sound libraries will be published;;
- Firmware updates are free and are installed via MIDI.

MIDI Expander Features:

- Portamento: fixed-time or fixed-rate;
- MIDI channel, pitch bend range, octave transposition settings;
- Trigger / Gate mode;
- Key priority: Lower, Upper, First, Last;
- VCO4 LFO, Delay1 LFO and Delay 1+2 LFO can sync to incoming MIDI clock;
- Pitch-to-MIDI conversion with PC and Octave Transpose settings.

Control Voltage Features:

- 1V/Octave CV and 5V/3.3V Gate outputs on MIDI out (via optional adapter cable);
- Scale and Fine Offset calibration;
- Octave and Semitone Offset.

Signal Processing Building Blocks:

- 4 VCOs each with saw, square and triangle waveforms;
- Each VCO has a separate LFO for PWM;
- Each VCO has a separate decay envelope for saw amplitude;
- Each VCO can generate complex, dynamic waveforms using foldover distortion;
- VCO2 can be hard synced to VCO1;
- Harmonizer with 3 voices, variable transposition;
- High quality guitar distortion for the harmonizer voices;
- EQ control and noise gate for the harmonizer voices;
- AD/ADSR envelope for the VCF; AR/ADSR envelope for the VCA;
- Smooth crossfade between harmonizer and synthesizer voices;
- VCF with Lowpass, Highpass, Bandpass and Notch mode;
- VCF has 12dB/oct and 24dB/oct mode;
- LFO with delay acting on VCO or VCF.

[Go to Table of Contents](#)

Effects:

- Bass guitar sound or synthesizer sounds can be routed separately to the effects;
- Chorus, Delay (clock syncable), Flanger, Slapback, Reverb (Chorus/Delay Effects), Overdrive and 4-band parametric Equalizer effects;
- The combination of EQ and the Overdrive effects is simultaneously available with either Chorus or Delay;
- The position in the signal chain of Overdrive and EQ is selectable.

Requirement for using the FI4:

- A 9V stabilized, 200mA, center-negative, Roland-Boss-type power supply.

Additional requirement for sound editing:

- A MIDI interface and two MIDI cables for use with a PC (Windows 7 and above) or MAC (OS X 10.6 (Snow Leopard) and above).
(Minimum screen resolution - 640x480 (VGA, at 50% zoom of the Editor window).)

Appendix

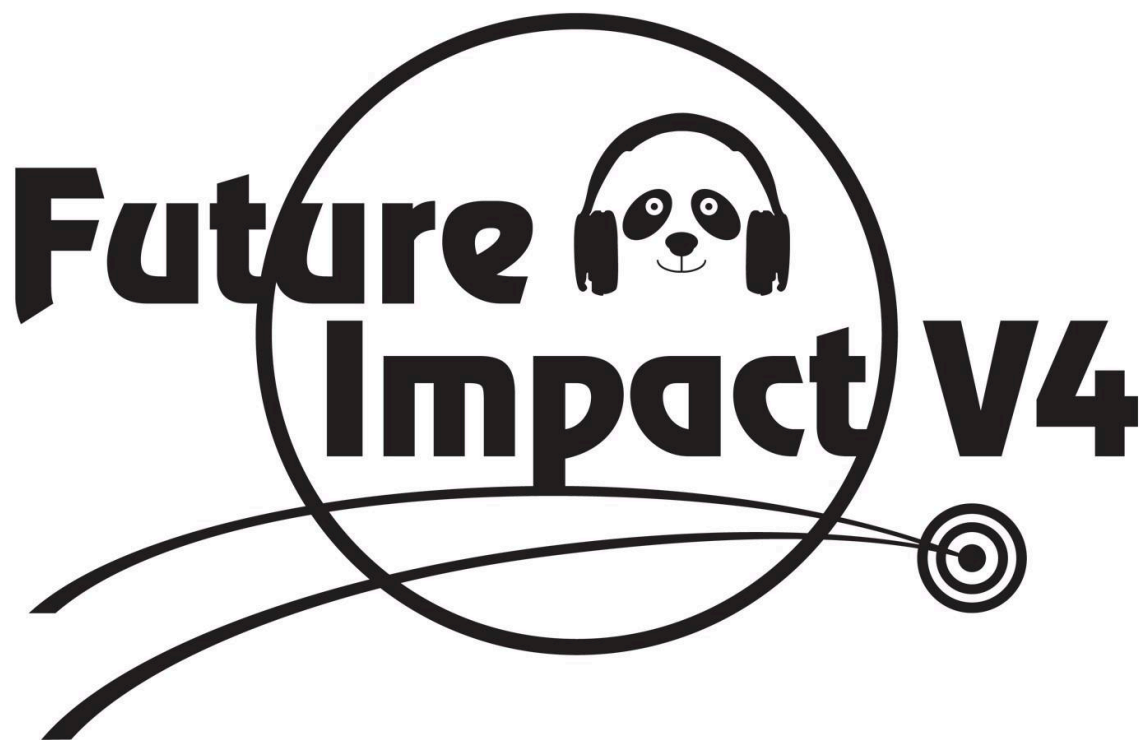

Algorithm Block Diagrams

Future Impact

A.SZALAY, 2015

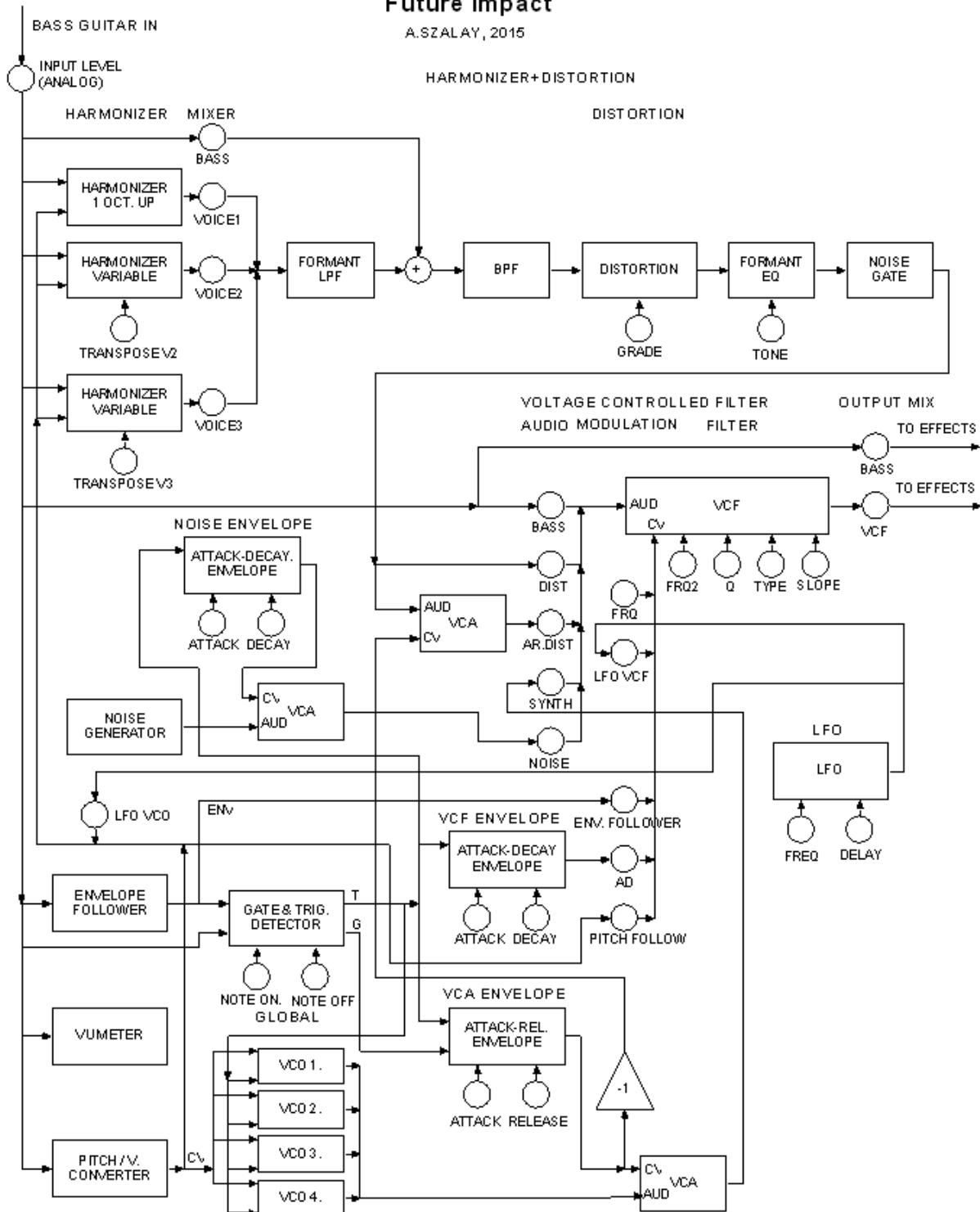

[Go to Table of Contents](#)

Future Impact Oscillators

A.SZALAY, 2024

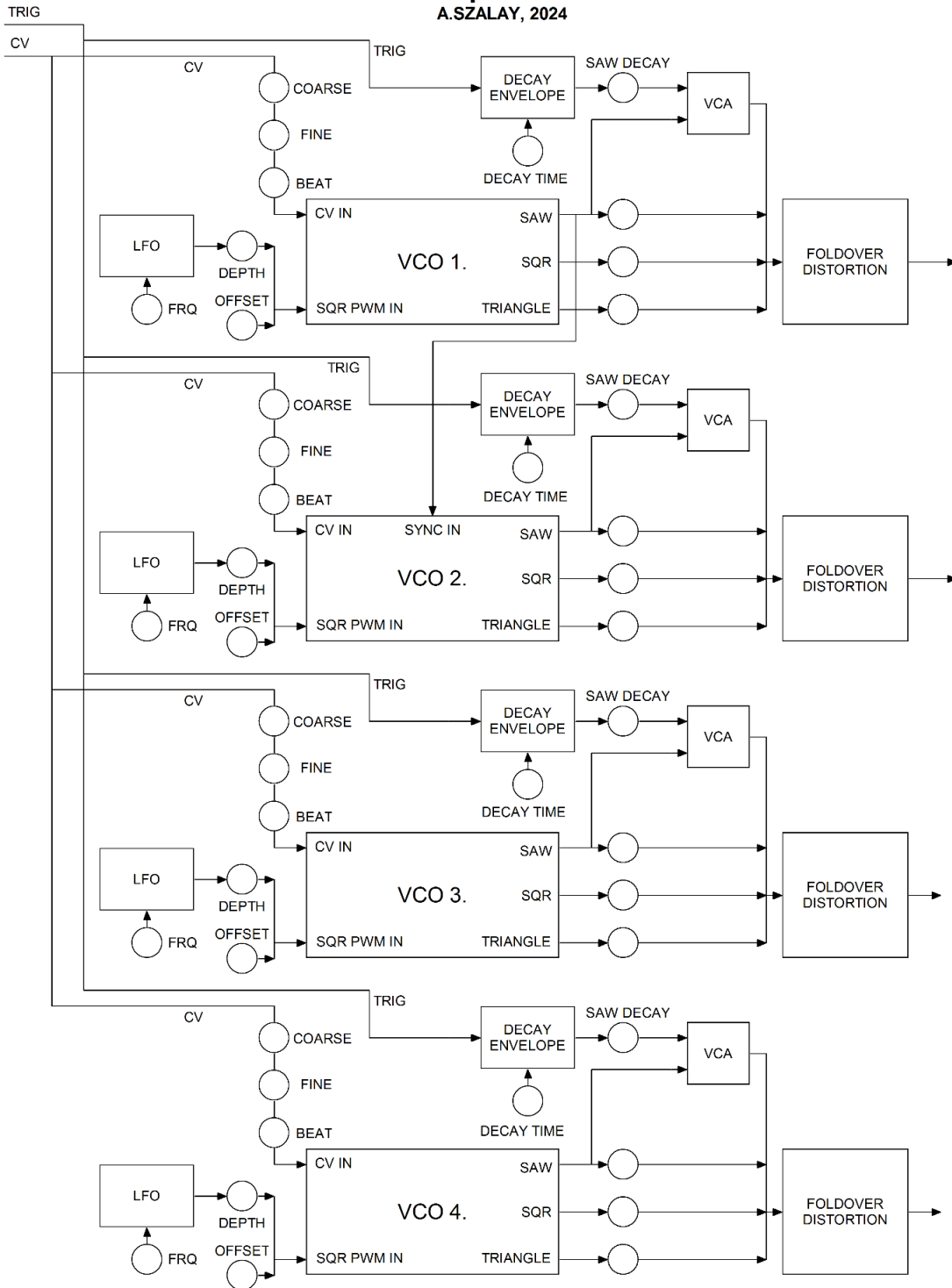

Future Impact Effect Routing

A.SZALAY, 2021

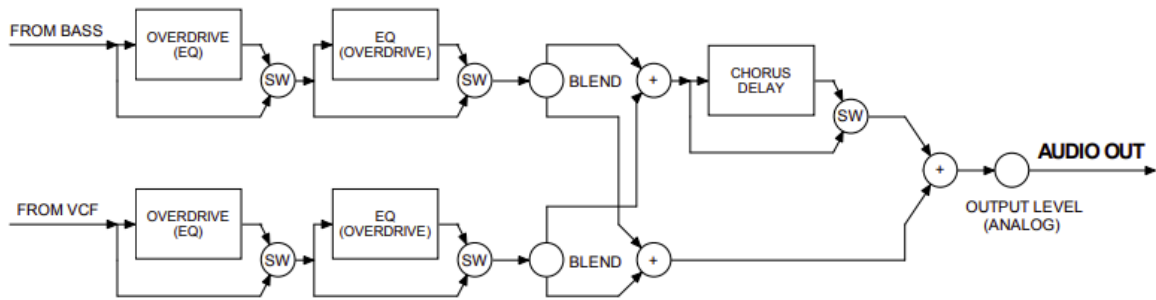

VCF Frequency Lookup Table

Note	Note No.	Freq (Hz)	Note No.	Freq (Hz)	Note No.	Freq (Hz)	Note No.	Freq (Hz)
C	36	65.41	48	130.81	60	261.63	72	523.25
C#	37	69.30	49	138.59	61	277.18	73	554.37
D	38	73.42	50	146.83	62	293.66	74	587.33
D#	39	77.78	51	155.56	63	311.13	75	622.25
E	40	82.41	52	164.81	64	329.63	76	659.26
F	41	87.31	53	174.61	65	349.23	77	698.46
F#	42	92.50	54	185.00	66	369.99	78	739.99
G	43	98.00	55	196.00	67	392.00	79	783.99
G#	44	103.83	56	207.65	68	415.30	80	830.61
A	45	110.00	57	220.00	69	440.00	81	880.00
A#	46	116.54	58	233.08	70	466.16	82	932.33
B	47	123.47	59	246.94	71	493.88	83	987.77

Note: Note number 60 is middle C.

VCF Frequency (continued)

Note	Note No.	Freq (Hz)	Note No.	Freq (Hz)	Note No.	Freq (Hz)	Note No.	Freq (Hz)
C	84	1046.50	96	2093.00	108	4186.01	120	8372.02
C#	85	1108.73	97	2217.46	109	4434.92	121	8869.84
D	86	1174.66	98	2349.32	110	4698.64	122	9397.27
D#	87	1244.51	99	2489.02	111	4978.03		
E	88	1318.51	100	2637.02	112	5274.04		
F	89	1396.91	101	2793.83	113	5587.65		
F#	90	1479.98	102	2959.96	114	5919.91		
G	91	1567.98	103	3135.96	115	6271.93		
G#	92	1661.22	104	3322.44	116	6644.88		
A	93	1760.00	105	3520.00	117	7040.00		
A#	94	1864.66	106	3729.31	118	7458.62		
B	95	1975.53	107	3951.07	119	7902.13		

LFO Frequency Lookup Tables

VCO1-4 Pulse Width LFO and VCO LFO3

Value	Frequency (Hz)	Value	Frequency (Hz)	Value	Frequency (Hz)	Value	Frequency (Hz)
1	0.03	21	0.63	41	1.23	61	1.83
2	0.06	22	0.66	42	1.26	62	1.86
3	0.09	23	0.69	43	1.29	63	1.89
4	0.12	24	0.72	44	1.32	64	1.92
5	0.15	25	0.75	45	1.35	65	1.95
6	0.18	26	0.78	46	1.38	66	1.98
7	0.21	27	0.81	47	1.41	67	2.01
8	0.24	28	0.84	48	1.44	68	2.04
9	0.27	29	0.87	49	1.47	69	2.07
10	0.30	30	0.90	50	1.50	70	2.10
11	0.33	31	0.93	51	1.53	71	2.13
12	0.36	32	0.96	52	1.56	72	2.16
13	0.39	33	0.99	53	1.59	73	2.19
14	0.42	34	1.02	54	1.62	74	2.22
15	0.45	35	1.05	55	1.65	75	2.25
16	0.48	36	1.08	56	1.68	76	2.28
17	0.51	37	1.11	57	1.71	77	2.31
18	0.54	38	1.14	58	1.74	78	2.34
19	0.57	39	1.17	59	1.77	79	2.37
20	0.60	40	1.20	60	1.80	80	2.40

VCO1-4 Pulse Width LFO and VCO3 LFO (continued)

Value	Frequency (Hz)	Value	Frequency (Hz)	Value	Frequency (Hz)
81	2.43	101	3.03	121	3.63
82	2.46	102	3.06	122	3.66
83	2.49	103	3.09	123	3.69
84	2.52	104	3.12	124	3.72
85	2.55	105	3.15	125	3.75
86	2.58	106	3.18	126	3.78
87	2.61	107	3.21	127	3.81
88	2.64	108	3.24		
89	2.67	109	3.27		
90	2.70	110	3.30		
91	2.73	111	3.33		
92	2.76	112	3.36		
93	2.79	113	3.39		
94	2.82	114	3.42		
95	2.85	115	3.45		
96	2.88	116	3.48		
97	2.91	117	3.51		
98	2.94	118	3.54		
99	2.97	119	3.57		
100	3.00	120	3.60		

VCO4 LFO

Value	Frequency (Hz)	Value	Frequency (Hz)	Value	Frequency (Hz)	Value	Frequency (Hz)
1	0.12	21	2.52	41	4.92	61	7.32
2	0.24	22	2.64	42	5.04	62	7.44
3	0.36	23	2.76	43	5.16	63	7.56
4	0.48	24	2.88	44	5.28	64	7.68
5	0.60	25	3.00	45	5.40	65	7.80
6	0.72	26	3.12	46	5.52	66	7.92
7	0.84	27	3.24	47	5.64	67	8.04
8	0.96	28	3.36	48	5.76	68	8.16
9	1.08	29	3.48	49	5.88	69	8.28
10	1.20	30	3.60	50	6.00	70	8.40
11	1.32	31	3.72	51	6.12	71	8.52
12	1.44	32	3.84	52	6.24	72	8.64
13	1.56	33	3.96	53	6.36	73	8.76
14	1.68	34	4.08	54	6.48	74	8.88
15	1.80	35	4.20	55	6.60	75	9.00
16	1.92	36	4.32	56	6.72	76	9.12
17	2.04	37	4.44	57	6.84	77	9.24
18	2.16	38	4.56	58	6.96	78	9.36
19	2.28	39	4.68	59	7.08	79	9.48
20	2.40	40	4.80	60	7.20	80	9.60

VCO4 LFO (continued)

Value	Frequency (Hz)	Value	Frequency (Hz)	Value	Frequency (Hz)
81	9.72	101	12.12	121	14.52
82	9.84	102	12.24	122	14.64
83	9.96	103	12.36	123	14.76
84	10.08	104	12.48	124	14.88
85	10.20	105	12.60	125	15.00
86	10.32	106	12.72	126	15.12
87	10.44	107	12.84	127	15.24
88	10.56	108	12.96		
89	10.68	109	13.08		
90	10.80	110	13.20		
91	10.92	111	13.32		
92	11.04	112	13.44		
93	11.16	113	13.56		
94	11.28	114	13.68		
95	11.40	115	13.80		
96	11.52	116	13.92		
97	11.64	117	14.04		
98	11.76	118	14.16		
99	11.88	119	14.28		
100	12.00	120	14.40		

Flexi Split Curves Lookup Table

Note	No.	Note	No.	Note	No.	Note	No.	Note	No.	Note	No.	Note	No.
		C1	4	C2	28	C3	52	C4	76	C5	100	C6	124
		C#1	6	C#2	30	C#3	54	C#4	78	C#5	102	C#6	126
		D1	8	D2	32	D3	56	D4	80	D5	104		
		D#1	10	D#2	34	D#3	58	D#4	82	D#5	106		
		E1	12	E2	36	E3	60	E4	84	E5	108		
		F1	14	F2	38	F3	62	F4	86	F5	110		
		F#1	16	F#2	40	F#3	64	F#4	88	F#5	112		
		G1	18	G2	42	G3	66	G4	90	G5	114		
		G#1	20	G#2	44	G#3	68	G#4	92	G#5	116		
		A1	22	A2	46	A3	70	A4	94	A5	118		
		A#1	24	A#2	48	A#3	72	A#4	96	A#5	120		
B0	2	B1	26	B2	50	B3	74	B4	98	B5	122		

Note: The note/curve number indicates where the upper split zone begins.

EU Directives on the Protection of the Environment

RoHS This product is compliant with the EU Directive 2002/95/EG for the Restriction of the use of Certain Hazardous Substances in Electrical and Electronic Equipment. No lead (Pb) cadmium (Cd), mercury (Hg), hexavalent chromium (Cr + 6), PBB or PBDE is intentionally added to this device. Any traces of impurities of these substances contained in the parts are below the RoHS specified threshold levels.

REACH This product is compliant with the European Union Directive EC1907/2006 and contains none or less than 0.1% of the chemicals listed as hazardous chemicals in the REACH regulation.

WEEE As with the disposal of all old electrical and electronic equipment, this product is not to be treated as regular household waste. Instead it should be handed over at the applicable collection point for the recycling of electrical and electronic equipment.

CE This product complies with the European Union Council Directives and Standards relating to electromagnetic compatibility EMC Directive (2006/95/EC) and the Low Voltage Directive (2004/108/EC). EMC compliance test report: EMC – 130930/1

Operation is subject to the following two conditions:

- 1) This device may not cause harmful interference;
- 2) This device must accept any interference received, including interference that may cause undesired operation.

Warranty Information

ONE-YEAR LIMITED WARRANTY. PROOF OF PURCHASE REQUIRED.

The manufacturer warrants that the unit will remain free from defects in materials and workmanship for one (1) year from the date of purchase. This warranty applies only to the original purchaser and is non-transferable. This warranty does not cover damage resulting from accident, misuse, abuse, alteration, or the use of incorrect current or voltage. Should the unit become defective within the warranty period, the manufacturer will either repair it or replace it, free of charge. After the warranty period has expired, the manufacturer will repair a defective unit in exchange for a fee.

WARNING: *Never* operate the BANK dial by foot; it must be operated *by hand only*. Damage to the BANK dial caused by improper use is not covered by the warranty.

Panda-Audio Ltd.

Széchenyi u. 8

2040 Budaörs

HUNGARY

<https://panda-audio.com>

Tel.: +36-20-3693-280

Email: info@panda-audio.com



Frequently-Asked Questions (FAQs)

Here are some common things we get asked by users. Please read through them to see if your question is covered and follow the links to the main manual where applicable.

- **I can no longer open the Editor Suite; what has happened and how do I fix this?**

In earlier versions, if you closed the Editor and then moved or deleted the last program file that was loaded (or its parent folder), then this could prevent the Editor from launching. This was fixed in v3.50.

However, should such a problem ever occur where the Editor Suite continually fails to launch, or closes immediately after launch, then please do the following (replacing the *italicized* text with your own username):

Windows users should delete the "FIEditor4" directory under the path "c:\Users\username\AppData\Local"

macOS users should delete the "FIEditor4" directory under the path "/Users/Username/Library/Application Support/".

The Editor Suite should then function correctly again.

- **Does the Future Impact generate MIDI notes?**

This question has been asked so many times over the last few years. We are happy to say that, finally in v4.11, this is indeed possible! You can now use whatever instrument you plug into the audio input to generate MIDI note data and play external synths or VSTs. Please see the section on [MIDI Triggering](#) for details.

- **How do I access the Tuner?**

Press and hold the ON/OFF footswitch for 0.8 seconds to turn the Tuner on; press the footswitch again to turn it off.

- **How do I choose which sound plays when the pedal is first powered on?**

The FI4 always starts up at the program most recently-saved using the EDIT dial. Navigate to the program you want to have as the start-up sound using the PROGRAM footswitch or your MIDI controller. Point the PARAMETER dial at one of the sound parameters. Turn the EDIT dial one click in any direction so the parameter value is displayed; before the display reverts, turn the EDIT dial one click in any direction then one click in the other direction. Press the EDIT dial to save.

Note: if you subsequently edit another program's parameters with the EDIT dial and save the changes, then *that* program will become the new startup program.

- **How do I change the order of sounds on my pedal?**

By far the easiest way to rearrange the sounds to your pedal is to use the new Manager feature of the [Editor Suite](#). There you can use the **DOWNLOAD FROM FI** feature to show the contents of your pedal in a Tile Window (a graphical representation of the 99 memory slots of your pedal). You can then drag and drop the tiles to change their positions and write the sounds to their new locations.

Note: You must first [write any edits made to the nine sound parameters into the program file](#), otherwise the sound will not play back as expected when loading via the Editor or when loading it back onto the pedal at a later date.

Connect your FI4 to your computer using a MIDI interface according to the instructions shown in the [Connecting to the Future Impact V4 Editor Suite](#) section of this manual. Then look at the instructions in the [Manager](#) section; it is very intuitive to use and it won't take long before you have learned how to use it fully.

- **How do I listen to and add new sounds to my pedal?**

By far the easiest way to browse, audition and add sounds to your pedal is to use the new Manager feature of the [Editor Suite](#). There you can browse sounds from our Online Program Database directly within the Editor Suite, download any you like and write them to the pedal and/or save them to your computer.

Connect your FI4 to your computer using a MIDI interface according to the instructions shown in the [Connecting to the Future Impact V4 Editor Suite](#) section of this manual. Then look at the instructions in the [Manager](#) section; it is very intuitive to use and it won't take long before you have learned how to use it fully.

(If you don't have your pedal or the Editor Suite to hand then you can listen to sound clips of programs on the website of the [Online Program Database](#) and download the individual files of any programs you like.)

- **Does the FI4 respond to MIDI clock signals?**

Yes! You can synchronize either the Delay effect or the VCO4 LFOs to incoming MIDI clock signals. (Other LFOs are not able to be synchronized.)

- **How do I update my pedal's firmware?**

You should always make sure the latest firmware version is installed on your FI4.

Check the number shown in your pedal's display when powering on.

You can update the FI4 unit's firmware to the latest version directly in your web browser (Chrome only) by going to <https://auraplug.com/fiupdate4/start.html> and following the on-screen instructions.

(An alternative way to update your pedal's firmware via the Editor Suite is detailed in the section on the [File Menu](#).)

[Go to Table of Contents](#)

- **Can I use an expression pedal to sweep the filter?**

Yes, you can! The filter cutoff in the FI4 is controlled by MIDI CC 11 and CC74. The pedal sweeps either 1, 2 or 4 octaves either side of the program's preset cutoff value (the value set by the **VCF FRQ** slider in the Editor). The sweep range is set by **VCF CONTROL RANGE** in the [Global Menu](#).

You will need either our midiBeam 4Control or a third-party piece of equipment to connect the expression pedal to the FI4's MIDI In port.

- **How do I use an expression pedal to control the LFO depth?**

LFO modulation depth to the filter cutoff and the oscillators' pitch is controlled by MIDI CC1. You can again use a third-party product to attach an expression pedal and send the relevant CC messages to the FI4

You can also plug in a MIDI keyboard to the FI4's MIDI IN port and use the keyboard's mod wheel.

- **Can I listen to and create sounds on the Editor Suite without using the pedal?**

In order to hear FI4 program sounds via the Editor Suite you must have the pedal connected to your computer. The sound is produced by the pedal; the Editor Suite just tells the pedal what settings to use. (Whilst it is technically possible to create programs on the Editor and save them to your PC without having the pedal attached, there would be little point as you would be unable to hear how they sound!)

- **I'm trying to use the FI4 to trigger my external MIDI synth but it's not sending any note messages; what am I missing?**

In order for this feature to work, two things are necessary:

Firstly, the external synth must be set to the same channel as the FI4. MIDI channel is set via the [Global Menu](#).

Secondly, MIDI Out needs to be enabled for each FI4 program that you wish to use to trigger external synths. This setting is located in the [External MIDI Tab](#). The first four programs of the v4.11 factory soundset have MIDI Out enabled.

- **How do I restore the factory patches to my pedal?**

There are a few ways to do this. One easy way is to use the online firmware updater tool and reflash your firmware. At the end of the firmware update process, you get the option to load the factory soundset onto the pedal. To do this, use a Chrome browser, go to <https://auraplug.com/fiupdate4/start.html> and follow the on-screen instructions.

A second way is via the Manager feature of the Editor Suite. Connect your FI4 to your computer using a MIDI interface according to the instructions shown in the [Connecting to the Future Impact V4 Editor Suite](#) section of this manual. Launch the [Editor Suite](#). Switch to the [Manager](#) view. In the File Commands click **SELECT**

[Go to Table of Contents](#)

DIRECTORY and select **GLOBAL**. Log in using your username and password for the [Online Program Database](#). From the Program Pane on the left, double-click the “Bank” folder, then the “v4.11 Factory Default Sounds”. From the File Commands, click **SELECT ALL** then click **SEND TO BANK**. Now from the Bank Commands in the upper-central portion of the screen, click **UPLOAD TO FI**. The soundset will now write to your pedal.

A third way is also via the [Editor](#). Connect your FI4 to your computer using the details in the links of the above paragraph. Go to <http://pandamidi.com/support> and download the factory patches. Once these are on your computer, unzip the folder. Then in the Menu Bar of the Editor Suite, go to the **File** menu, click **Select Directory** and locate the downloaded folder “v411_sounds”. Click the **WRITE ALL** button in Program Display at the top left corner of the Editor window to write the factory default programs back to your pedal.

- **When I use the FI4 to change programs on other MIDI devices, sometimes the PC message being sent out isn’t the same as the one showing in its display; why is that?**

If MIDI Out in the [External MIDI Tab](#) is enabled on any given FI program, then it will send out the PC message as set by the PC slider next to it in the tab. This can be a different number from the FI4’s own currently-selected program. Please see the section on [MIDI Triggering](#) for details.

- **Can I play chords on the FI4, is it polyphonic?**

These are really two separate questions. The FI4 cannot respond to polyphonic input, that is, you cannot play chords on your guitar and have the FI4 synthesize them. The FI4 responds only to monophonic input pitches. You can however play chords using the FI4 in the sense of being able to set the oscillators to different pitches to give a polyphonic output. With the clever use of Flexi Controllers routed to oscillator pitches, you can even change the chord quality on the fly.

If you are using the FI4 purely as a substitute for a single-effect pedal such as chorus, distortion, flanger, etc. (where the synthesizer section is not in use) then of course you can play with full chordal input. You can also use full chordal input if the synthesizer note is currently being held via the [Sustain](#) feature.

If you are using the FI4’s [MIDI Triggering](#) feature to play an external polyphonic synthesizer, then it is possible to achieve some polyphonic results: if you set a long envelope release time on the synth, then playing (monophonic) arpeggios (with careful muting between the individual notes) will allow multiple notes to overlap on the synthesizer. You can use this in conjunction with [Sustain](#) for very musical results.

- **How do I set a custom window size of the Editor?**

Move the mouse cursor to the lower-right corner of the Editor Suite window. When the mouse cursor changes to a two-way arrow, click and hold the left mouse button then drag the arrow to set the Editor Suite window to the desired size.

[Go to Table of Contents](#)

- **What is the difference between the FI I, the FI v3 and the FI V4?**

The FI I and FI v3 are absolutely identical to each other, aside from the differing decal on the top. Both can run firmware up to v3.61 and access .prg and .pr3 program files.

FI V4 has different hardware and a different firmware structure from its predecessors. Its firmware is incompatible with the older pedals. It can access program files from any version of the pedal (.prg, .pr3 and .pr4).

- **Can I load the V4 firmware onto my FI I or FI v3?**

No! (See the question above.)

- **Can I load all my old patches onto the new V4 pedal?**

Yes! V4 can load patches from any previous FI pedal, both .prg and .pr3 file formats.

- **Can I freeze/sustain the sound?**

Yes! The FI4 has a [Sustain](#) feature. You can use it to indefinitely sustain the synth portion of a sound at a fixed pitch and then play over the top of it.

- **How do I set the MIDI channel on the FI4?**

The MIDI channel is set using the [Global Menu](#). Please read that section for details.

- **I'm using the FI4 to trigger external synths but everything is out of tune; what's going on?**

In order for [MIDI Triggering](#) to function correctly, the pitch bend amount on your external synthesizer must be set to the same value as the pitch bend in the FI4 program (adjusted via the [External MIDI Tab](#) of the [MIDI Block](#) of the Editor). This is essential for using pitch bend to correct any pitch detection errors and to interpret playing techniques such as hammer-ons and pull-offs. For best results, use the maximum pitch bend that your synthesizer allows (whilst ensuring it still matches the FI4's own setting). If your synthesizer has separate values for pitch bend up and down, these must be set to the same value as each other.



[Go to Table of Contents](#)